

Service
Service
Service



Service Manual



TABLE OF CONTENTS

Technical specification 1-1
 Features 1-1

Accessories 1-2
 Instruction For Use 1-2..1-6
 Safety & Warnings 1-7

Service hints

 Repair positions 2-1
 Dismantling CD-door 2-1
 Handling chip components 2-2
 Service tools 2-2

Pin description of ICs 3-1..3-4
 Start-up procedure 3-5
 Service Test Program 3-5
 Blockdiagram 3-6

Circuit diagrams

 Supply part 4-1
 CD part 4-2
 DSP part 4-3
 Audio part 4-4
 Control part 4-5
 Layout diagram - copper side view 4-6
 Layout diagram - component side view 4-7

Jack board

 Circuit diagram 5-1
 Layout diagram 5-2

Exploded view 6-1
 Mechanical partslist 6-1

Electrical partslist 7-1..7-6



© Copyright 2001 Philips Consumer Electronics B.V. Eindhoven, The Netherlands
 All rights reserved. No part of this publication may be reproduced, stored in a retrieval system or transmitted, in any form or by any means, electronic, mechanical, photocopying, or otherwise without the prior permission of Philips.

Published by LX 0236 Service Audio Printed in The Netherlands Subject to modification

GB 3140 785 32190



PHILIPS

TECHNICAL SPECIFICATION

General

Dimensions (Dia x H) : 147.5 x 35mm
 Weight without batteries : 220g

Laser

Output power : <5mW (3mW typ.)
 Wavelength : 780nm

Shock resistance

+X/-X direction : $\geq 2.5g$
 +Y/-Y direction : $\geq 2.5g$
 +Z/-Z direction : $\geq 2.0g$

Power supply modes

SUPPLY MODE	Voltage range
	CD
DC-IN socket	2.9 - 6.5V
Primary batteries 2 x LR6	1.7 - 3.6V

Battery lifetime

BATTERY TYPE	CD MODE	CD MODE	MP3 MODE	MP3 MODE
	ESP ON ESP OFF	ESP LP	ESP ON	ESP LP
Primary batteries 2 x LR6	≥ 7 h (11h typ.)	≥ 11 h (15h typ.)	≥ 7 h (11h typ.)	≥ 14 h (23h typ.)

Battery level detection – CD mode

DETECTION LEVEL	Primary batteries
Battery empty	1.8V +100/-50mV
Battery week 1	battery empty level + 0.9V \pm 100mV
Battery week 2	battery empty level + 0.6V \pm 100mV
Battery week 3	battery empty level + 0.3V \pm 100mV

Measurement setup CD

Use Audio Signal disc SBC429 4822 397 30184

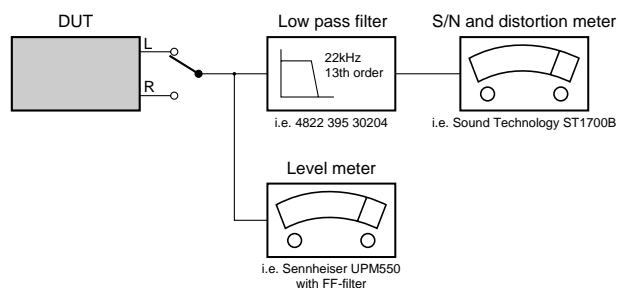

Current consumption

OPERATION MODE	DC-IN SUPPLY (4.5V)		BATT. SUPPLY (2.25V)	
	CD ESP ON ESP OFF	MP3 ESP ON	CD ESP ON ESP OFF	MP3 ESP ON
CD Play mode	140mA typ.	140mA typ.	170mA typ.	170mA typ.
CD Jump mode	220mA typ.	320mA typ.	300mA typ.	400mA typ.
Stand-by (excl.recharge)	90mA typ.		450 μ A typ.	

Headphone out (measured with 16 Ω load, DBB/ESP off)

Output power (THD=10%)
 /17 version only : 10mW (+1/-3dB)
 all other versions : 10mW (+1/-3dB)
 Frequency response CD (1mW) : 100Hz-20kHz within 6dB
 S/N ratio CD (unwght) : ≥ 80 dB (83dB typ.)
 S/N ratio CD (A-wght) : ≥ 82 dB (85dB typ.)
 THD+N CD (1kHz, 1mW) : $\leq 1\%$ (0.2% typ.)
 Channel crosstalk (1kHz, no load) : ≤ -24 dB (-44dB typ.)
 Channel unbalance (-40dB) : ≤ 5 dB
 Volume attenuation (1kHz) : ≥ 60 dB

Dynamic Bass Boost DBB

DBB STAGE	Frequency response		
	63kHz	1kHz	10kHz
DBB 1	+5dB \pm 2dB	0dB \pm 2dB	0dB \pm 2dB
DBB 2	+9dB \pm 2dB	0dB \pm 2dB	+5dB \pm 2dB

Feature Overview

FEATURES OF CD-PORTABLE/MP3	ACT400 (all versions)
TUNER FM / MW	- / -
CD-REWRITABLE COMPATIBILITY	●
ELECTRONIC SKIP PROTECTION CDDA / MP3	180s / 495s
ESP DRAM SIZE	64Mbit
HOLD / RESUME FUNCTION	● / ●
DBB STAGES	2
ACOUSTIC FEEDBACK	●
PROGRAM MEMORY	99
RECHARGE FUNCTION NiCd / NiMH	- / -
CORD REMOTE CONTROL PREPARED	●
DISPLAY BACKLIGHT	-
LINE / DIGITAL OUTPUT	- / -

INSTRUCTION FOR UES

controls

controls

front view

- ① **display**
- ② **-**
adjusts the volume (down)
- ③ **+**
adjusts the volume (up)
- ④ **◀◀**
skips backward and searches backward
- ⑤ **▶▶**
skips forward and searches forward
- ⑥ **◀**
mp3-cd only: selects the previous album or skips backward
- ⑦ **▶**
mp3-cd only: selects the next album or skips forward
adjusts eq (bass and treble)
- ⑧ **⏮**
switches the set on, starts playback and interrupts playback
- ⑨ **■**
stops playback and switches the set off

rear view

- ① **DC**
to connect the external power supply
- ② **3.5mm**
3.5 mm line out to connect the headphones
the remote control
this set to the audio input of your stereo equipment
- ③ **hold/resume/off**
hold locks all buttons
resume stores the last position played
off switches resume and hold off
- ④ **esp**
electronic skip protection prevents music interruptions caused by shocks
- ⑤ **eq**
selects the bass and treble adjustment
- ⑥ **mode**
selects playback options such as **shuffle** and **repeat**
- ⑦ **⏪**
opens the cd lid
- ⑧ **battery compartment**

front view

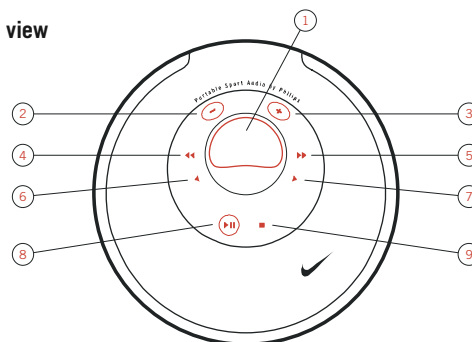

rear view

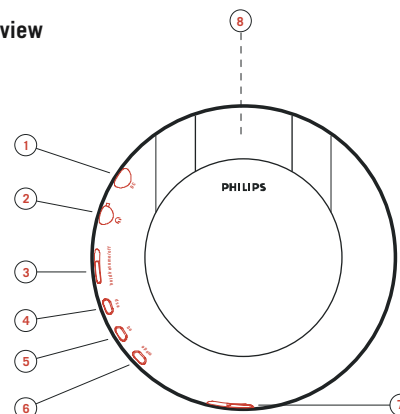

caution

use of controls or adjustments or performance of procedures other than herein may result in hazardous radiation exposure or other unsafe operation.

the model and serial numbers are located inside the cd door.

ACCESSORIES

ACCESSORIES FOR CD-PORTABLE / MP3	ACT400				
	/00C	/01	/05	/11	/17
AY 3170/00 AC/DC Adaptor 3140 118 33630	X				
AY 3170/02 AC/DC Adaptor 3140 118 32020		X		X	
AY 3170/05 AC/DC Adaptor 3140 118 33610			X		
AY 3170/17 AC/DC Adaptor 3140 118 33640					X
SBC HJ020/77E Stereo Headphone 9082 100 00787	X	X	X	X	X
AY3773 Remote control 3140 118 51170	X	X	X	X	X
AY3286 Handstrap 3140 113 10550	X	X	X	X	X

general information

how to make a cd-rom with mp3 files

use your computer's cd burner to record ("burn") the music files from your hard disc to a cd-rom. use either ISO 9660 disc format or UDF. some cd burner software like e. g. "DirectCD" support the UDF format.

make sure that the file names of the mp3 files end with .mp3.

supported formats

this set supports:
 disc format: ISO 9660, joliet, multisession, UDF,
 enhanced music cd, mixed mode cd
 mp3 bit rate: 32-320 kbps and variable bit rate
 total number of music files and albums: around 350
 (with a typical file name length of 20 characters)

note: the number of music files that can be played depends on the length of the file names. with short file names more files will be supported.

all trademarks used are owned by their respective owners.

INSTRUCTION FOR USE

general information

firmware upgrade

occasionally, philips releases new software ("firmware") for your set.

- 1 connect the mains adapter to **DC** on the set and to the wall socket (see "mains adapter").
- 2 keep mode pressed for 3 seconds.
the type of your set and the current version of the firmware are displayed. Upgrade? is displayed.
- 3 press ■.
- 4 visit the homepage <http://www.nike-philips.com>. check if there is a firmware file for your set and if the firmware version is higher than the current version of your set. download the file and burn it on a cd-rom.
- 5 insert the cd-rom into the set and keep mode pressed for 3 seconds.
Upgrade? is displayed.
- 6 press ►||.
Upgrading is displayed and upgrading starts. this may take some minutes. after upgrading is finished, Upgrade complete is scrolled.
Wrong upgrade file is scrolled: your set already has the latest firmware or the downloaded file does not correspond to your set.
Upgrade file defect is scrolled: the upgrade file has been damaged during the download or when burning the cd-rom. download the file again, burn a new cd-rom and try again.
No upgrade file is scrolled: no upgrade file was found on the inserted cd-rom.

note: if upgrading is interrupted accidentally, repeat step 6 until upgrading is completed successfully.

power supply

batteries (supplied or optionally available)

inserting batteries

open the battery compartment and insert 2 alkaline batteries of type AA (LR6, UM3).

do not use old and new or different types of batteries in combination.

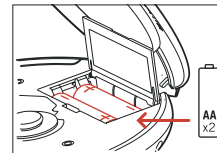

indication of empty batteries

replace the batteries or connect the mains adapter as soon as  blinks and Replace batteries is scrolled.

remove batteries if they are empty or if the set will not be used for a long time.

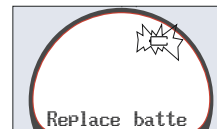

batteries contain chemical substances, so they should be disposed of properly.

average playing time of batteries under normal conditions:

	alkaline batteries
esp on	10 hours
esp and powersaving on:	
audio disc	15 hours
mp3-cd	24 hours

note: to switch on powersaving, press esp repeatedly during playback until ESP is shown (see "esp and powersaving").

power supply / head phones

power adapter (supplied or optionally available)

use only the AY 3170 power adapter (4.5 V/300 mA direct current, positive pole to the center pin). any other product may damage the set.

- 1 make sure the local voltage corresponds to the adapter's voltage. if your power adapter is equipped with a voltage selector, set this selector to the local power voltage if necessary.
- 2 connect the power adapter to **DC** on the set and to the wall outlet.

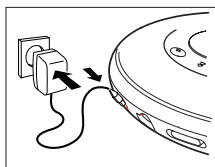

note: always disconnect the adapter if you are not using it.

headphones (HJ020)

connect the supplied headphones to .

note:  can also be used for connecting this psa to your hifi system. adjust the volume and sound on the psa and your hifi system.

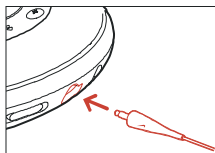

use your head when using headphones

hearing safety

do not play your headphones at a high volume. hearing experts advise that continuous use at high volume can permanently damage your hearing.

traffic safety

do not use headphones while driving a vehicle. it may create a hazard and it is illegal in many countries. even if your headphones are an open-air type designed to let you hear outside sounds, do not turn up the volume so high that you cannot hear what is going on around you.

basic functions

playing a disc

with this set you can play
all pre-recorded audio cds
all finalized audio cdrs and cdrws
mp3-cds (cd-roms with mp3 files)

- 1 push the  slider to open the cd lid.
- 2 insert a disc, printed side up, by pressing gently on the disc's center so that it fits onto the hub. close the lid by pressing it down.
- 3 press ►|| to start playback.
Reading CD is displayed. playback starts.
the track type (CD or MP3), the current track number and the elapsed playing time are displayed. for an mp3 track, the album number is also displayed and the filename is scrolled twice.
- 4 press ■ to stop playback.
the total number of tracks, the track types (CD, MP3), the number of albums on an mp3-cd and the total playing time (of an audio disc only) are displayed.
- 5 to remove the disc, hold it by its edge and press the hub gently while lifting the disc.

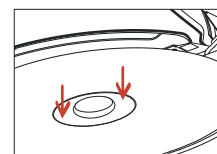
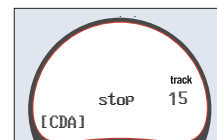
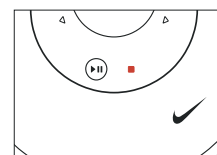
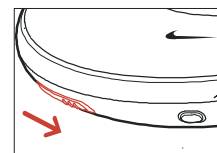

notes:

after pressing ►|| it may take some time until the first mp3 track is played.

20 seconds after pressing ■ the set switches off automatically.

INSTRUCTION FOR USE

basic functions

pause

press **⏸** to interrupt playback.

the time where playback was interrupted is blinking.

to resume playback press **▶** again.

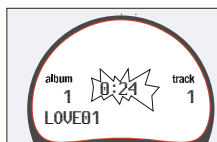

basic functions

volume and sound

volume adjustment

adjust the volume by using **-** **+**.



bass adjustment

1 press **eq** once during playback to select the bass adjustment.

the current bass setting blinks.

2 press **▶** repeatedly to select either:

- No Bass: no bass enhancement
 - Bass 1: moderate bass enhancement
 - Bass 2: strong bass enhancement
- the selected bass setting blinks.

3 press **eq** to confirm your selection.

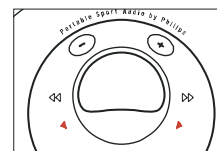

treble adjustment

1 press **eq** twice during playback to select the treble adjustment.

the current treble setting blinks.

2 press **▶** repeatedly to select either:

- No Treble: no treble enhancement
 - Treble: treble enhancement
- the selected treble setting blinks.

3 press **eq** to confirm your selection.



basic functions

selecting and searching on all discs

selecting a track during playback

briefly press **◀** or **▶** once or several times to skip to the beginning of the current, previous or subsequent track.

playback continues with the selected track.



searching for a passage during playback

keep **◀** or **▶** pressed to find a particular passage in backward or forward direction.

searching starts and playback continues at a low volume. for cd audio tracks the search speeds up after 2 seconds.

release the button at the desired passage.

normal playback continues.

*note: during **repeat**, **shuffle** or **shuffle all**, searching is only possible within the current track.*

basic functions

selecting on mp3-cds

selecting an album during playback

briefly press **◀** or **▶** once or several times to skip to the first track of the current, previous or subsequent album.

the first track of the selected album is played.

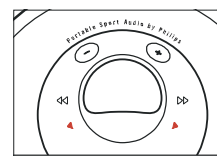

selecting a track during playback

1 keep **◀** or **▶** pressed to skip quickly to previous or subsequent mp3 tracks.

skipping starts and speeds up after 5 seconds.

2 release the button at the desired track.

playback continues with the selected track.

*note: to skip from track to track at low speed, use **◀** or **▶**.*

INSTRUCTION FOR USE

features

playing tracks repeatedly or in random order – mode

press **mode** repeatedly during playback to select either:

shuffle album (with mp3-cds only):

all tracks of the current album are played in random order once.

shuffle all: all tracks of the disc are played in random order once.

repeat shuffle album (with mp3-cds only): all tracks of the current album are played repeatedly in random order .

repeat shuffle all: all tracks of the disc are played repeatedly in random order .

repeat: the current track is played repeatedly.

repeat album (with mp3-cds only): all tracks of the current album are played repeatedly.

repeat all: the entire disc is played repeatedly.

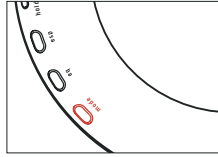

playback starts in the selected mode after 2 seconds.

to return to normal playback, press **mode** repeatedly until **repeat** and **shuffle** disappear .

features

storing the last position played – resume

you can store the last position played. when restarting, playback will continue from where you have stopped.

- 1 switch the slider to **resume** during playback to activate resume.
resume is shown.
- 2 press **■** whenever you want to stop playback.
- 3 press **▶||** to resume playback.
playback continues from where you have stopped.

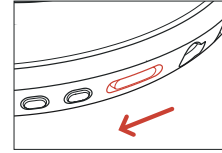

to deactivate **resume**, switch the slider to **off**.
resume disappears.



locking all buttons – hold

you can lock all buttons of the set. when you press any key, no action will be executed then.

switch the slider to **hold** to activate hold.

resume is shown and **Hold** is displayed all buttons are locked. when pressing any key, **Hold** is displayed.



to deactivate **hold**, switch the slider to **off**.
resume disappears.

features

esp and powersaving

with a conventional portable disc player the music may stop while you are jogging, for example. the electronic skip protection protects the psa against loss of sound caused by light vibrations or shocks. **continuous playback is ensured. esp does not protect the psa against damage caused by dropping!**

press **esp** repeatedly during playback to select either:

ESP on: **ESP** is shown and esp is switched on.

ESP , powersave is shown. esp and powersaving are switched on, resulting in a longer battery lifetime and a shorter skip protection.

ESP off: **ESP** disappears. esp and powersaving are switched off for cd audio tracks to achieve the highest sound quality.

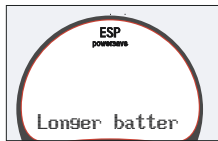

accessories

remote control AY 3773 (supplied or optionally available)

controls

- ① 3.5 mm plug to connect the headphones
- ② **hold**
locks all buttons
- ③ **stop**
stops playback and switches the set off
- ④ **◀ / ▶**
skips and searches forward / backward tracks
- ⑤ **◀ / ▶**
mp3-cd only: selects the next / previous
- ⑥ **▶||**
switches the set on, starts playback and interrupts playback
- ⑦ **volume**
adjusts the volume

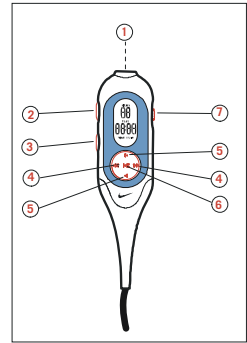

connecting the remote control

use only the AY 3773 remote control.

- 1 press **■** on the set twice to switch off the set.
- 2 firmly connect the remote control to **Ⓡ** on the set.
- 3 firmly connect the headphones to the plug on the remote control.
- 4 on the remote control keep **▶||** pressed for 1 second to switch on the set and to start playback.
playback starts the album number (mp3-cds only) and the track number are displayed on the remote control's display.

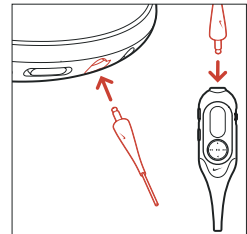

beep

a beep confirms that you have pressed a button or that the batteries are empty.

keep **eq** pressed for 2 seconds to switch beep either on or off:

Beep is displayed: beep is switched on.

No beep is displayed: beep is switched off.

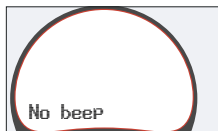
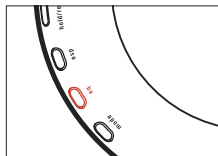

INSTRUCTION FOR USE

accessories

adjust the volume and sound on the psa and your remote control.

note: replace the batteries as soon as no battery is displayed on the remote control's display.

handstrap (AY 3286)

secure your digital audio player during sport activity by using the supplied hand strap.

fit the psa player into the rubber buckle, with the headphone / remote socket aligned to the socket hole.

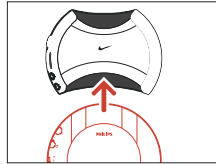

position your hand until the fit is snug and comfortable.

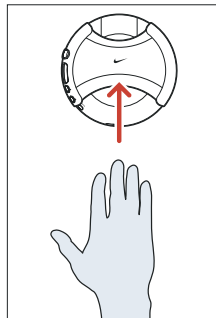

troubleshooting

warning

under no circumstances should you try to repair the set yourself as this will invalidate the warranty.

if a fault occurs, first check the points listed, before taking the set for repair. if you are unable to solve a problem by following these hints, consult your dealer or service center.

problem	solution
no power, playback does not start	insert the batteries correctly. replace the batteries. connect the mains adapter securely.
Hold indication and /or no reaction to controls	deactivate hold. disconnect the set from the power supply or take out the batteries for a few seconds.
no sound or bad sound quality	press ► to resume playback. adjust the volume. check and clean the connections. keep this set away from active mobile phones or strong magnetic fields.
Pls insert cd or no audio file indication	insert a disc, label upwards. clean or replace the disc. wait until the steamed up lens has cleared. make sure you have inserted an audio disc or an mp3-cd.
unfinalized cd indication	make sure the inserted cdr or cdrw is finalized.

accessories

clip magnets

wear your remote control and secure your headphone cord with these wearable magnets.

- 1 check the polarity of the 2 button magnets. insert the big button magnet underneath your garment.
- 2 clip the small button magnet on your outer garment. clip the remote control on top.
- 3 secure your headphone cord with the "butterfly" magnet clip.

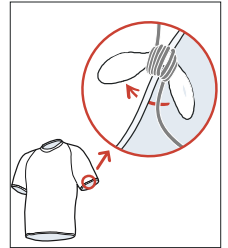
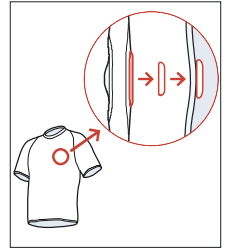

WARNING:

KEEP OUT OF REACH OF SMALL CHILDREN TO AVOID CHOKING HAZARD.

KEEP THE MAGNETS A WAY FROM CREDIT CARDS, TAPES AND ANY ITEMS WHICH MAYBE SENSITIVE TO THE MAGNETS.

USERS OF PACEMAKERS OR OTHER IMPLANTED DEVICES SHOULD CONSULT THEIR PHYSICIAN BEFORE USING MAGNETS OR DEVICES THAT MAY GENERATE ELECTRO-MAGNETIC INTERFERENCE.

troubleshooting

problem	solution
music file is not played	make sure that the file names of the mp3 files end with .mp3
missing directories on mp3-cd	make sure the total number of files and albums on your mp3-cd does not exceed 350. only albums with mp3 files are shown.
the disc skips tracks	clean or replace the disc. make sure repeat, repeat album, shuffle are not selected.
music skips or popping sound when playing an mp3 file	play the music file on your computer. if the problem persists, encode the audio track again and make a new cd-rom.
music is interrupted and Oops indication	switch esp on.

Canada

English: This digital apparatus does not exceed the Class B limits for radio noise emissions from digital apparatus as set out in the Radio Interference Regulations of the Canadian Department of Communications.

*The set complies with the FCC-Rules, Part 15 and with 21 CFR 1040.10. Operation is subject to the following two conditions:
1. This device may not cause harmful interference, and
2. This device must accept any interference received, including interference that may cause undesired operation.*

SAFETY & WARNINGS

ⓐ WARNING

All ICs and many other semiconductors are susceptible to electrostatic discharges (ESD). Careless handling during repair can reduce life drastically.

When repairing, make sure that you are connected with the same potential as the mass of the set via a wristband with resistance. Keep components and tools at this potential.

ⓑ ATTENTION

Tous les IC et beaucoup d'autres semi-conducteurs sont sensibles aux décharges statiques (ESD). Leur longévité pourrait être considérablement écourtée par le fait qu'aucune précaution n'est prise à leur manipulation.

Lors de réparations, s'assurer de bien être relié au même potentiel que la masse de l'appareil et enfilez le bracelet sertit d'une résistance de sécurité.

Veiller à ce que les composants ainsi que les outils que l'on utilise soient également à ce potentiel.

ESD



Ⓓ WARNING

Alle ICs und viele andere Halbleiter sind empfindlich gegenüber elektrostatischen Entladungen (ESD). Unvorsichtige Behandlung im Reparaturfall kann die Lebensdauer drastisch reduzieren.

Sorgen Sie dafür, daß Sie im Reparaturfall über ein Pulsarmband mit Widerstand mit dem Massepotential des Gerätes verbunden sind.

Halten Sie Bauteile und Hilfsmittel ebenfalls auf diesem Potential.

Ⓝ WAARSCHUWING

Alle IC's en vele andere halfgeleiders zijn gevoelig voor electrostatische ontladingen (ESD).

Onzorgvuldig behandelen tijdens reparatie kan de levensduur drastisch doen verminderen. Zorg ervoor dat u tijdens reparatie via een polsband met weerstand verbonden bent met hetzelfde potentiaal als de massa van het apparaat.

Houd componenten en hulpmiddelen ook op ditzelfde potentiaal.

ⓓ AVVERTIMENTO

Tutti IC e parecchi semi-conduttori sono sensibili alle scariche statiche (ESD).

La loro longevità potrebbe essere fortemente ridotta in caso di non osservazione della più grande cauzione alla loro manipolazione. Durante le riparazioni occorre quindi essere collegato allo stesso potenziale che quello della massa del apparecchio tramite un braccialetto a resistenza.

Assicurarsi che i componenti e anche gli utensili con quali si lavora siano anche a questo potenziale.

ⓐ AVAILABLE ESD PROTECTION EQUIPMENT :

anti-static table mat	large 1200x650x1.25mm	4822 466 10953
	small 600x650x1.25mm	4822 466 10958
anti-static wristband		4822 395 10223
connection box (3 press stud connections, 1MΩ)		4822 320 11307
extendible cable (2m, 2MΩ, to connect wristband to connection box)		4822 320 11305
connecting cable (3m, 2MΩ, to connect table mat to connection box)		4822 320 11306
earth cable (1MΩ, to connect any product to mat or to connection box)		4822 320 11308
KIT ESD3 (combining all 6 prior products - small table mat)		4822 310 10671
wristband tester		4822 344 13999

ⓐ

Safety regulations require that the set be restored to its original condition and that parts which are identical with those specified be used.

Safety components are marked by the symbol

ⓑ

Les normes de sécurité exigent que l'appareil soit remis à l'état d'origine et que soient utilisées les pièces de rechange identiques à celles spécifiées.

Les composants de sécurité sont marqués

SAFETY



Ⓓ

Bei jeder Reparatur sind die geltenden Sicherheitsvorschriften zu beachten. Der Originalzustand des Gerätes darf nicht verändert werden. Für Reparaturen sind Originalersatzteile zu verwenden.

Sicherheitsbauteile sind durch das Symbol

Ⓝ

Veiligheidsbepalingen vereisen, dat het apparaat in zijn oorspronkelijke toestand wordt teruggebracht en dat onderdelen, identiek aan de gespecificeerde, worden toegepast. De Veiligheidsonderdelen zijn aangeduid met het symbool

ⓓ

Le norme di sicurezza estigono che l'apparecchio venga rimesso nelle condizioni originali e che siano utilizzati i pezzi di ricambio identici a quelli specificati.

Componenti di sicurezza sono marcati con

ⓐ

DANGER: Invisible laser radiation when open. AVOID DIRECT EXPOSURE TO BEAM.



Ⓢ

Varning !

Osynlig laserstrålning när apparaten är öppnad och spårren är urkopplad. Betrakta ej strålen.

ⒹK

Advarsel !

Usynlig laserstrålning ved åbning når sikkerhedsafbrydere er ude af funktion. Undgå udsættelse for strålning.

ⒻN

Varoitus !

Avatussa laitteessa ja suojalukituksen ohitettaessa olet alttiina näkymättömälle laserisäteilylle. Älä katso säteeseen !

ⓐ

After servicing and before returning the set to customer perform a leakage current measurement test from all exposed metal parts to earth ground, to assure no shock hazard exists.

The leakage current must not exceed 0.5mA.

ⓑ

"Pour votre sécurité, ces documents doivent être utilisés par des spécialistes agréés, seuls habilités à réparer votre appareil en panne".

SERVICE HINTS

REPAIR POSITION COPPERSIDE

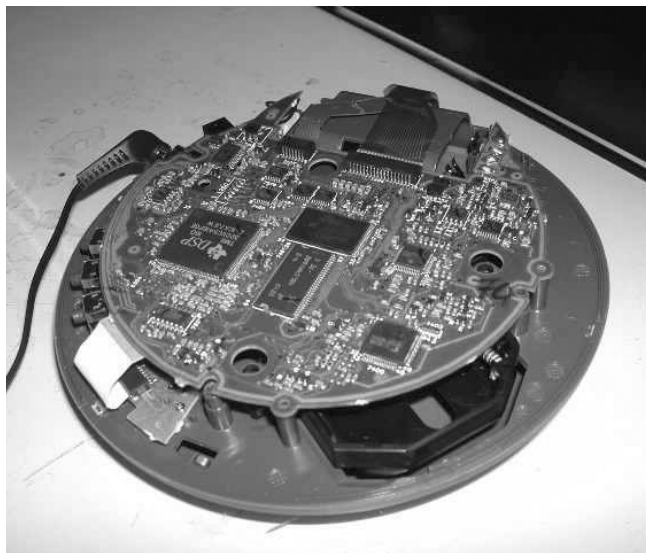

To get access to the copperside of the printed board assembly proceed as follows:

1. Remove bottom screws 2pcs (under the plate-decoration)
Remove screws 3pcs (in the CD-door)
2. Lift the bottom-cabinet
3. Supply the unit via external DC-socket
4. Take care that the door switch is closed during measurements

DISMANTLING THE CD-DOOR

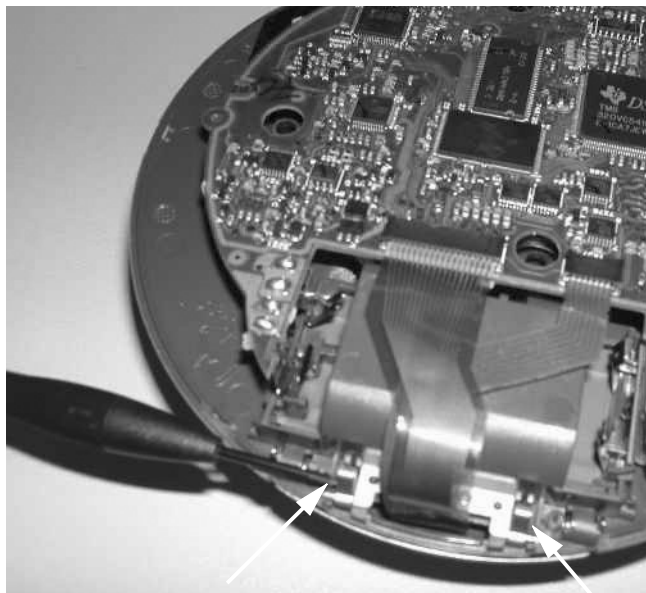

To dismantle the CD-door proceed as follows:

1. Dismantle bottom board
2. Remove screw 2pcs as indicated in the picture above
3. Dismantle the CD-door carefully

REPAIR POSITION COMPONENTSIDE



To get access to the compomentside of the printed board assembly proceed as follows:

1. Remove bottom screws 2pcs (under the plate-decoration)
Remove screws 3pcs (in the CD-door)
2. Lift the bottom-cabinet
3. Disconnect membrane
(flex-foil connector on component side of jack board)
4. Take care that the door switch is closed during measurements

HANDLING CHIP COMPONENTS

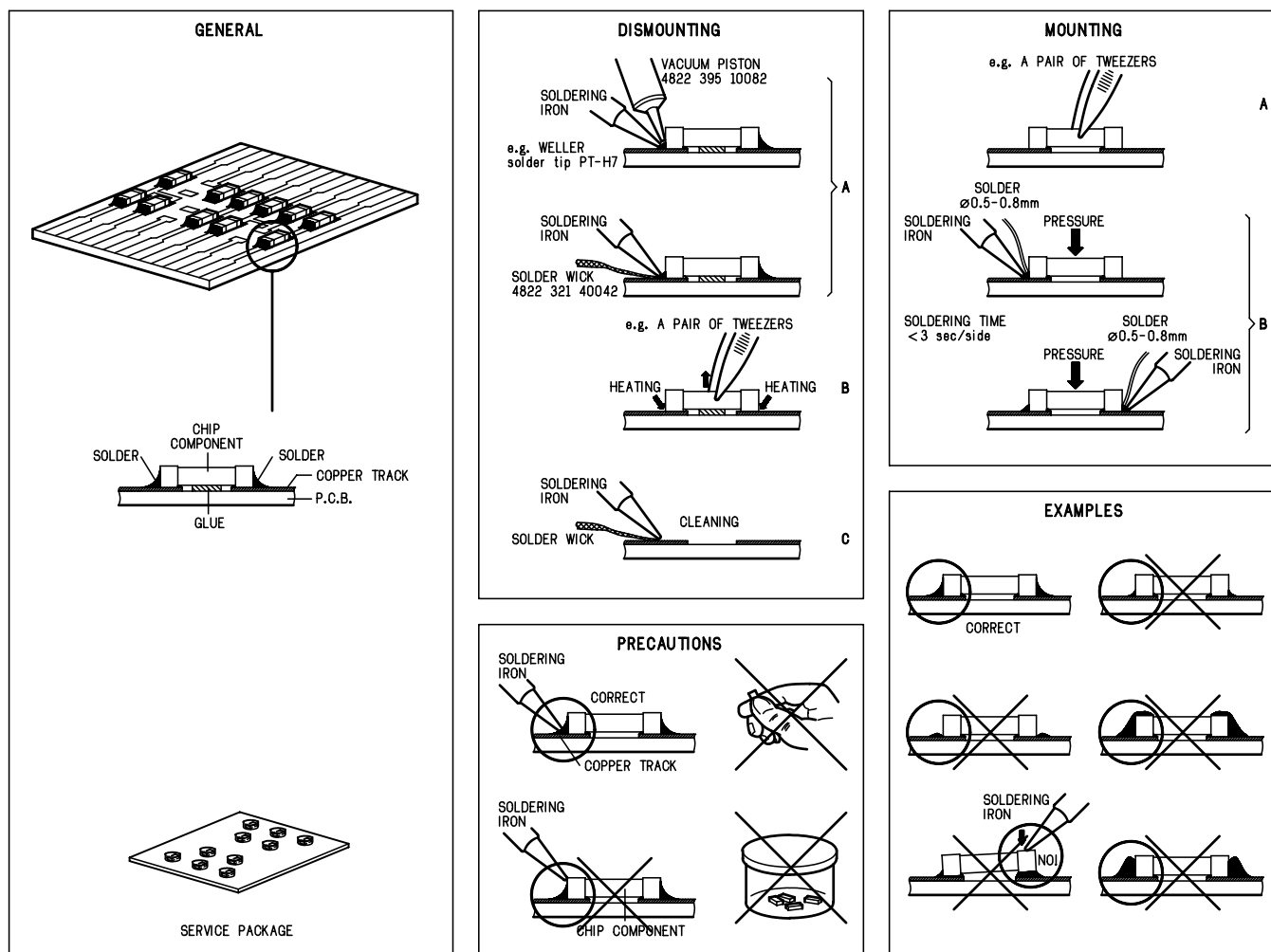

SERVICE TOOLS

Audio signal disc **SBC429**

Playability test disc **SBC444**

Test disc **5** (disc without errors) + Test disc **5A** (disc with dropout errors
black spots and fingerprints) **SBC426/ SBC426A**

4822 397 30184

4822 397 30245

4822 397 30096

ESD PROTECTION EQUIPMENT

Anti-static table mat large 1200x650x1.25mm

small 600x650x1.25mm

4822 466 10953

4822 466 10958

Anti-static wristband

4822 395 10223

Connection box (3press stud connections, 1MΩ)

4822 320 11307

Extendible cable (2m, 2MΩ, to connect wristband to connection box)

4822 320 11305

Connecting cable (3m, 2MΩ, to connect table mat to connection box)

4822 320 11306

Earth cable (1MΩ, to connect any product to mat or to connection box)

4822 320 11308

KIT ESD3 (combining all 6 prior products - small table mat)

4822 310 10671

Wristband tester

4822 344 13999

PIN DESCRIPTION OF INTEGRATED CIRCUITS

TZA1024 – HF-PREAMPLIFIER AND LASER SUPPLY CIRCUIT

<i>Pin</i>	<i>Name</i>	<i>Direction</i>	<i>Description</i>
1	LD	HF-preamp → CD-drive	current output to laser diode
2	VCCL	+2.6V	laser supply voltage
3	CFIL	→ HF-preamp	external filter capacitor
4	MON	CD-drive → HF-preamp	laser monitor diode input
5	DIN	CD-drive → HF-preamp	central diode input
6	GND	GND	ground
7	PWRON	CD10 → HF-preamp	power-on select input
8	CMFB	+2.6V / 2	common mode feedback voltage input
9	RFFB	→ HF-preamp	external RF feedback resistor
10	RFEQO	HF-preamp →	RF amplifier output
11	CDRW	CD10 → HF-preamp	gain select input for CDDA/CDRW
12	EQSEL	CD10 → HF-preamp	equalizer/speed select input
13	VCC2	+2.6V	supply voltage
14	RGADJ	GND	external laser supply gain adjust resistor

SC111259AFTA – SERVO DRIVER & POWER MANAGEMENT IC

<i>Pin</i>	<i>Name</i>	<i>Direction</i>	<i>Description</i>
1	SLEEP	μP → servo driver	sleep input
2	WAKE	μP → servo driver	wake input
3	VR	+VR	reference voltage input (motor driver)
4	ERR4	CD10 → servo driver	control signal input (slide error signal)
5	CF4	→ servo driver	phase correction capacitor connect (CH4)
6	CF3	→ servo driver	phase correction capacitor connect (CH3)
7	ERR3	CD10 → servo driver	control signal input (radial error signal)
8	ERR2	DSP/μP → servo driver	control signal input (disc speed error signal)
9	CF2	→ servo driver	phase correction capacitor connect (CH2)
10	CF1	→ servo driver	phase correction capacitor connect (CH1)
11	ERR1	CD10 → servo driver	control signal input (focus error signal)
12	OUT1A	servo driver → CD-drive	positive drive output (CH1)
13	PGND1	GND	H-bridge driver ground
14	OUT1B	servo driver → CD-drive	negative drive output (CH1)
15	VIN12	+A	CH1 and CH2 H-bridge driver supply voltage
16	OUT2B	servo driver → CD-drive	negative drive output (CH2)
17	PGND2	GND	H-bridge driver ground
18	OUT2A	servo driver → CD-drive	positive drive output (CH2)
19	OUT3A	servo driver → CD-drive	positive drive output (CH3)
20	PGND2	GND	H-bridge driver ground
21	OUT3B	servo driver → CD-drive	negative drive output (CH3)
22	VIN34	+A	CH3 and CH4 H-bridge driver supply voltage
23	OUT4B	servo driver → CD-drive	negative drive output (CH4)
24	PGND4	GND	H-bridge driver ground
25	OUT4A	servo driver → CD-drive	positive drive output (CH4)
26	VG	servo driver →	charge pump output
27	C2H	→ servo driver	charge pump capacitor connect
28	C1H	→ servo driver	charge pump capacitor connect
29	C1L	→ servo driver	charge pump capacitor connect
30	C2L	→ servo driver	charge pump capacitor connect
31	VIN	battery → servo driver	battery supply voltage
32	RSTB	servo driver →	reset block output
33	CHGSW	servo driver → charge circuit	transistor drive output for battery charger
34	RS	charge circuit → servo driver	OpAmp non-inverting input for battery charger
35	INM2	→ servo driver	error amplifier inverting input
36	RF2	→ servo driver	error amplifier output
37	DCIN	+DC	DC power supply from AC/DC adaptor
38	VDET	servo driver →	DCIN over voltage and VIN low voltage detect output
39	VREF	servo driver →	Voltage reference circuit output
40	DTC	→ servo driver	max. duty control voltage input for power management
41	VOUT	servo driver → DC/DC converter	PWM output for power management
42	VC	→ servo driver	power management power supply
43	CGND	GND	internal ground
44	RF1	servo driver →	OpAmp output for power management
45	INM1	→ servo driver	OpAmp inverting input for power management
46	CLK	→ servo driver	clock input
47	OE	DSP → servo driver	output enable for motor drivers
48	CHGON	μP → servo driver	charge enable for battery charger

SAA7324 – DECODER, DIGITAL SERVO IC AND D/A-CONVERTER CD10 (low voltage version)

<i>Pin</i>	<i>Name</i>	<i>Direction</i>	<i>Description</i>
1	HFREF	→ CD10	comparator common mode input
2	HFIN	→ CD10	comparator signal input
3	ISLICE	CD10 →	current feedback from data slicer
4	VSSA1	GND	analog ground 1
5	VDDA1	+2.6V	analog supply voltage 1
6	IREF	CD10 →	reference current output pin
7	VRIN	CD10 →	reference voltage for servo ADC's
8	D1	CD-drive → CD10	unipolar current input (central diode signal input)
9	D2	CD-drive → CD10	unipolar current input (central diode signal input)
10	D3	CD-drive → CD10	unipolar current input (central diode signal input)
11	D4	CD-drive → CD10	unipolar current input (central diode signal input)
12	R1	CD-drive → CD10	unipolar current input (satellite diode signal input)
13	R2	CD-drive → CD10	unipolar current input (satellite diode signal input)
14	VSSA2	GND	analog ground 2
15	CROUT	CD10 → X-TAL	crystal/resonator output
16	CRIN	X-TAL → CD10	crystal/resonator input
17	VDDA2	+2.6V	analog supply voltage 2
18	LN	CD10 →	DAC left channel differential output - negative
19	LP	CD10 →	DAC left channel differential output - positive
20	VNEG	GND	DAC negative reference input
21	VPOS	+2.6V	DAC positive reference input
22	RN	CD10 →	DAC right channel differential output - negative
23	RP	CD10 →	DAC right channel differential output - positive
24	SELPLL	CD10 →	selects whether internal clock multiplier PLL is used
25	TEST1	GND	test control input 1; this pin should be tied low
26	CL16	CD10 →	16.9344 MHz system clock output
27	DATA	CD10 → DSP	serial data output (3-state)
28	WCLK	CD10 → DSP	word clock output (3-state)
29	SCLK	CD10 → DSP	serial bit clock output (3-state)
30	EF	CD10 → DSP	C2 error flag output (3-state)
31	TEST2	GND	test control input 2; this pin should be tied low
32	KILL	CD10 →	kill output (programmable; open-drain)
33	VSSD1	GND	digital ground 2
34	V2/V3	CD10 →	versatile I/O: input versatile pin 2 or output versatile pin 3 (open-drain)
35	WCLI	DSP → CD10	word clock input (for data loopback to DAC)
36	SDI	DSP → CD10	serial data input (for data loopback to DAC)
37	SCLI	DSP → CD10	serial bit clock input (for data loopback to DAC)
38	RESETn	μP → CD10	power-on reset input (active low)
39	SDA	μP ↔ CD10	microcontroller interface data I/O line (open-drain output)
40	SCL	μP → CD10	microcontroller interface clock line input
41	RAB	μP → CD10	microcontroller interface R/W and load control line input (4-wire bus mode)
42	SILD	μP → CD10	microcontroller interface R/W and load control line input (4-wire bus mode)
43	STATUS	CD10 →	servo interrupt request line/decoder status register output (open-drain)
44	TEST3	GND	test control input 3; this pin should be tied low
45	RCK	DSP → CD10	subcode clock input
46	SUB	CD10 → DSP	P-to-W subcode bits output (3-state)
47	SFSY	CD10 → DSP	subcode frame sync output (3-state)
48	SBSY	CD10 → DSP	subcode block sync output (3-state)
49	CL11/4	CD10 →	11.2896 MHz or 4.2336 MHz (for microcontroller) clock output
50	VSSD2	GND	digital ground 3
51	DOBM	CD10 →	bi-phase mark output (externally buffered; 3-state)
52	VDDD1P	+2.6V (+VR)	digital supply voltage 2 for periphery
53	CFLG	CD10 →	correction flag output (open-drain)
54	RA	CD10 → servo driver	radial actuator output
55	FO	CD10 → servo driver	focus actuator output
56	SL	CD10 → servo driver	slide control output
57	VDDD2C	+2.6V	digital supply voltage 3 for core
58	VSSD3	GND	digital ground 4
59	MOTO1	CD10 → servo driver	motor output 1; versatile (3-state)
60	MOTO2	CD10 →	motor output 2; versatile (3-state)
61	V4	CD10 → HF-preamp	versatile output pin 4
62	V5	CD10 → HF-preamp	versatile output pin 5
63	V1	innerswitch → CD10	versatile input pin 1
64	LDON	CD10 → HF-preamp	laser drive on output (open-drain)

TMS320DA150PGE160 – DIGITAL SIGNAL PROCESSOR DSP

<i>Pin</i>	<i>Name</i>	<i>Direction</i>	<i>Description</i>
1	CVSS1	GND	ground for core CPU
2	A22	DSP ↔	parallel address bus
3	CVSS2	GND	ground for core CPU
4	DVDD1	+3.3V	power supply for I/O pins
5	A10	DSP ↔	parallel address bus
6	HD7	CD10 → MUTE	reference current output pin
7	A11	DSP ↔	parallel address bus
8	A12	DSP ↔	parallel address bus
9	A13	DSP ↔	parallel address bus
10	A14	DSP ↔	parallel address bus
11	A15	DSP ↔	parallel address bus
12	CVDD1	+core	power supply for core CPU
13	HAS	→ DSP	address strobe input
14	DVSS1	GND	ground for I/O pins
15	CVSS3	GND	ground for core CPU
16	CVDD2	+core	power supply for core CPU
17	HCS	→ DSP	chip select input
18	HR/W	→ DSP	read/write input
19	READY	→ DSP	data ready input, indicates that an external device is prepared for a bus transaction to be completed
20	PS	DSP → EPROM	program space select output, always high unless driven low for communicating to a particular external space
21	DS	DSP →	data space select output, always high unless driven low for communicating to a particular external space
22	IS	DSP →	I/O space select output, always high unless driven low for communicating to a particular external space
23	R/W	DSP → DRAM	read/write signal output, indicates transfer direction during communication to an external device
24	MSTRB	DSP →	memory strobe signal output
25	IOSTRB	DSP →	I/O strobe signal output
26	MSC	DSP →	microstate complete output, indicates completion of all software wait states
27	XF	DSP → CD10	external flag output, latched software programmable signal
28	HOLDA	DSP →	Hold acknowledge, indicates that the processor is in a hold state
29	IAQ	DSP →	instruction acquisition signal output
30	HOLD	→ DSP	hold input, asserted to request control of address, data and control lines
31	BIO	→ DSP	branch control input
32	MP/MC	→ DSP	microprocessor/microcomputer mode select
33	DVDD2	+3.3V	power supply for I/O pins
34	CVSS4	GND	ground for core CPU
35	BDR1	CD10 →	serial data receive input
36	BFSR1	CD10 → DSP	frame synchronization pulse for receive input
37	CVSS5	GND	ground for core CPU
38	BCLKR1	→ DSP	serial shift clock
39	HCNTL0	→ DSP	control input
40	DVSS2	GND	ground for I/O pins
41	BCLKR0	CD10 → DSP	serial shift clock
42	BCLKR2	μP → DSP	serial shift clock
43	BFSR0	CD10 → DSP	frame synchronization pulse for receive input
44	BFSR2	CD10 → DSP	frame synchronization pulse for receive input
45	BDR0	CD10 → DSP	serial data receive input
46	HCNTL1	→ DSP	control input
47	BDR2	μP → DSP	serial data receive input
48	BCLKX0	DSP → CD10	transmit clock
49	BCLKX2	μP → CD10	transmit clock
50	CVSS6	GND	ground for core CPU
51	HINT	DSP →	interrupt output, used to interrupt the host
52	CVDD3	+core	power supply for core CPU
53	BFSX0	DSP → CD10	frame synchronization pulse for transmit input/output
54	BFSX2	μP → DSP	frame synchronization pulse for transmit input/output
55	HRDY	DSP →	ready output, informs the host when the HPI is ready for the next transfer
56	DVDD3	+3.3V	power supply for I/O pins
57	DVSS3	GND	ground for I/O pins
58	HD0	DSP ↔ CD10	parallel bidirectional data bus
59	BDX0	DSP → CD10	serial data transmit output
60	BDX2	DSP → μP	serial data transmit output
61	IACK	DSP →	interrupt acknowledge signal output
62	HBIL	→ DSP	byte identification, identifies the first or second byte of transfer
63	NMI	→ DSP	nonmaskable interrupt input
64	INT0	CD10 → DSP	external user interrupt input
65	INT1	CD10 → DSP	external user interrupt input
66	INT2	CD10 → DSP	external user interrupt input
67	INT3	μP → DSP	external user interrupt input
68	CVDD4	+core	power supply for core CPU
69	HD1	DSP ↔ CD10	parallel bidirectional data bus

70	CVSS7	GND	ground for core CPU
71	BCLKX1	DSP ↔	transmit clock
72	DVSS4	GND	ground for I/O pins
73	BFSX1	DSP →	frame synchronization pulse for transmit input/output
74	BDX1	DSP → servo driver	serial data transmit output
75	DVDD4	+3.3V	power supply for I/O pins
76	DVSS5	GND	ground for I/O pins
77	CLKMD1	→ DSP	clock mode select signal input, allow selection of different clock modes
78	CLKMD2	→ DSP	clock mode select signal input, allow selection of different clock modes
79	CLKMD3	→ DSP	clock mode select signal input, allow selection of different clock modes
80	HPI16	→ DSP	HPI16 mode selection
81	HD2	DSP ↔ CD10	parallel bidirectional data bus
82	TOUT	DSP →	timer output, signals a pulse when the on-chip timer counts down past zero
83	EMU0	DSP ↔	emulator 0 pin
84	EMU1/OFF	DSP ↔	emulator 1 pin / disable all outputs, used as an interrupt to or from the emulator system
85	TDO	DSP →	IEEE standard 1149.1 test data output
86	TDI	→ DSP	IEEE standard 1149.1 test data input
87	TRST	→ DSP	IEEE standard 1149.1 test reset
88	TCK	→ DSP	IEEE standard 1149.1 test clock
89	TMS	→ DSP	IEEE standard 1149.1 test mode select
90	CVSS8	GND	ground for core CPU
91	CVDD5	+core	power supply for core CPU
92	HPIENA	→ DSP	HPI module select
93	DVSS6	GND	ground for I/O pins
94	CLKOUT	DSP → DRAM/FLASH	clock output signal
95	HD3	DSP ↔ CD10	parallel bidirectional data bus
96	X1	DSP →	output pin from an internal oscillator for the crystal
97	X2/CLKIN	CD10 → DSP	clock/oscillator input
98	RS	μP → DSP	reset input
99	D0	DSP ↔ DRAM/FLASH	parallel data bus
100	D1	DSP ↔ DRAM/FLASH	parallel data bus
101	D2	DSP ↔ DRAM/FLASH	parallel data bus
102	D3	DSP ↔ DRAM/FLASH	parallel data bus
103	D4	DSP ↔ DRAM/FLASH	parallel data bus
104	D5	DSP ↔ DRAM/FLASH	parallel data bus
105	A16	DSP ↔ DRAM/FLASH	parallel address bus
106	DVSS7	GND	ground for I/O pins
107	A17	DSP ↔ DRAM/FLASH	parallel address bus
108	A18	DSP ↔ DRAM/FLASH	parallel address bus
109	A19	DSP ↔ DRAM/FLASH	parallel address bus
110	A20	DSP ↔ DRAM/FLASH	parallel address bus
111	CVSS9	GND	ground for core CPU
112	DVDD5	+3.3V	power supply for I/O pins
113	D6	DSP ↔ DRAM/FLASH	parallel data bus
114	D7	DSP ↔ DRAM/FLASH	parallel data bus
115	D8	DSP ↔ DRAM/FLASH	parallel data bus
116	D9	DSP ↔ DRAM/FLASH	parallel data bus
117	D10	DSP ↔ DRAM/FLASH	parallel data bus
118	D11	DSP ↔ DRAM/FLASH	parallel data bus
119	D12	DSP ↔ DRAM/FLASH	parallel data bus
120	HD4	DSP → servo driver	parallel bidirectional data bus
121	D13	DSP ↔ DRAM/FLASH	parallel data bus
122	D14	DSP ↔ DRAM/FLASH	parallel data bus
123	D15	DSP ↔ DRAM/FLASH	parallel data bus
124	HD5	DSP ↔	parallel bidirectional data bus
125	CVDD6	+core	power supply for core CPU
126	CVSS10	GND	ground for I/O pins
127	HDS1	→ DSP	data strobe input
128	DVSS8	GND	ground for I/O pins
129	HDS1	→ DSP	data strobe input
130	DVDD6	+3.3V	power supply for I/O pins
131	A0	DSP ↔ DRAM/FLASH	parallel address bus
132	A1	DSP ↔ DRAM/FLASH	parallel address bus
133	A2	DSP ↔ DRAM/FLASH	parallel address bus
134	A3	DSP ↔ DRAM/FLASH	parallel address bus
135	HD6	DSP ↔	parallel bidirectional data bus
136	A4	DSP ↔ DRAM/FLASH	parallel address bus
137	A5	DSP ↔ DRAM/FLASH	parallel address bus
138	A6	DSP ↔ DRAM/FLASH	parallel address bus
139	A7	DSP ↔ DRAM/FLASH	parallel address bus
140	A8	DSP ↔ DRAM/FLASH	parallel address bus
141	A9	DSP ↔ DRAM/FLASH	parallel address bus
142	CVDD7	+core	power supply for core CPU
143	A21	DSP ↔ DRAM/FLASH	parallel address bus
144	DVSS9	GND	ground for I/O pins

START- UP PROCEDURE

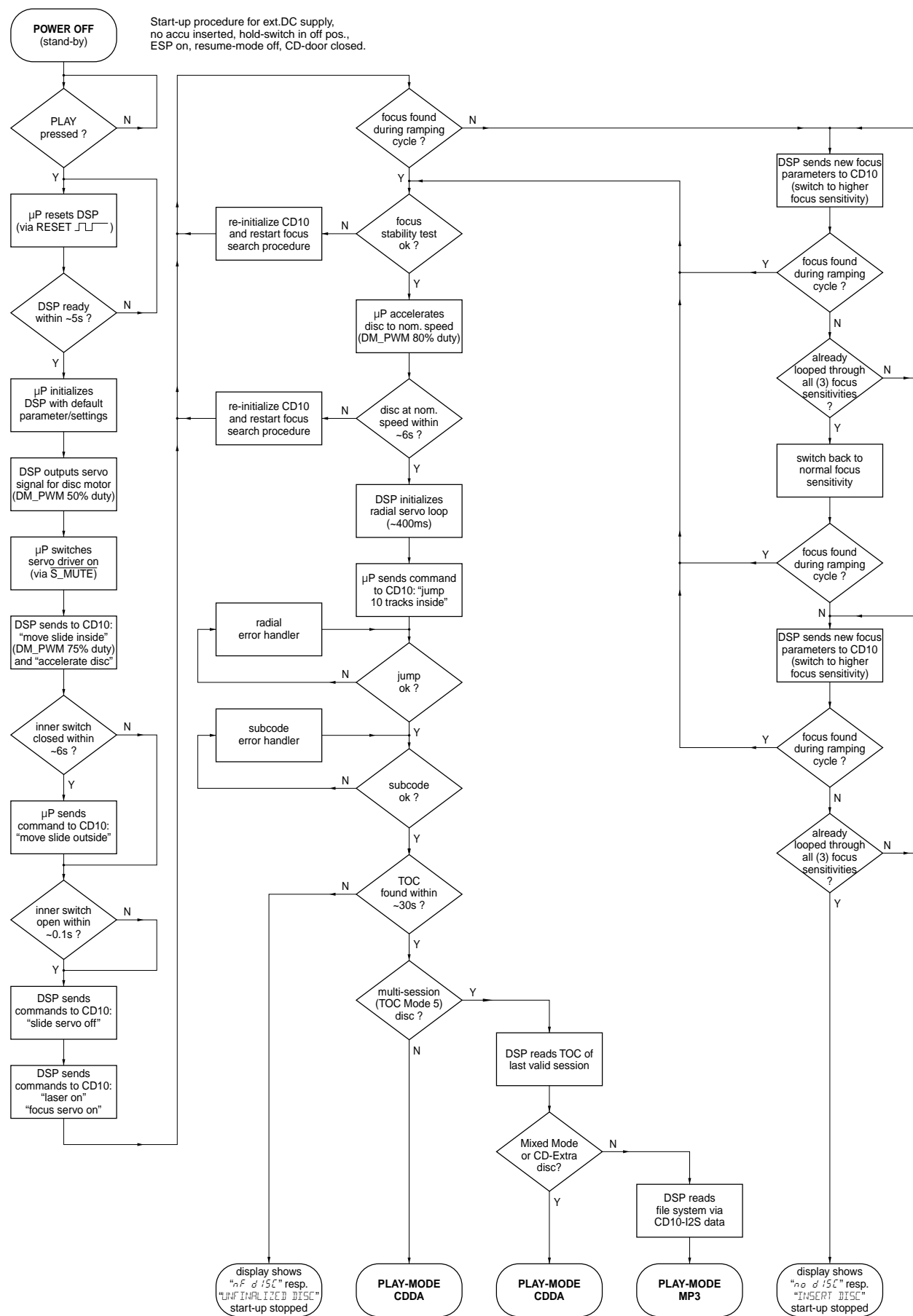

SERVICE TEST PROGRAM - FLOW CHART

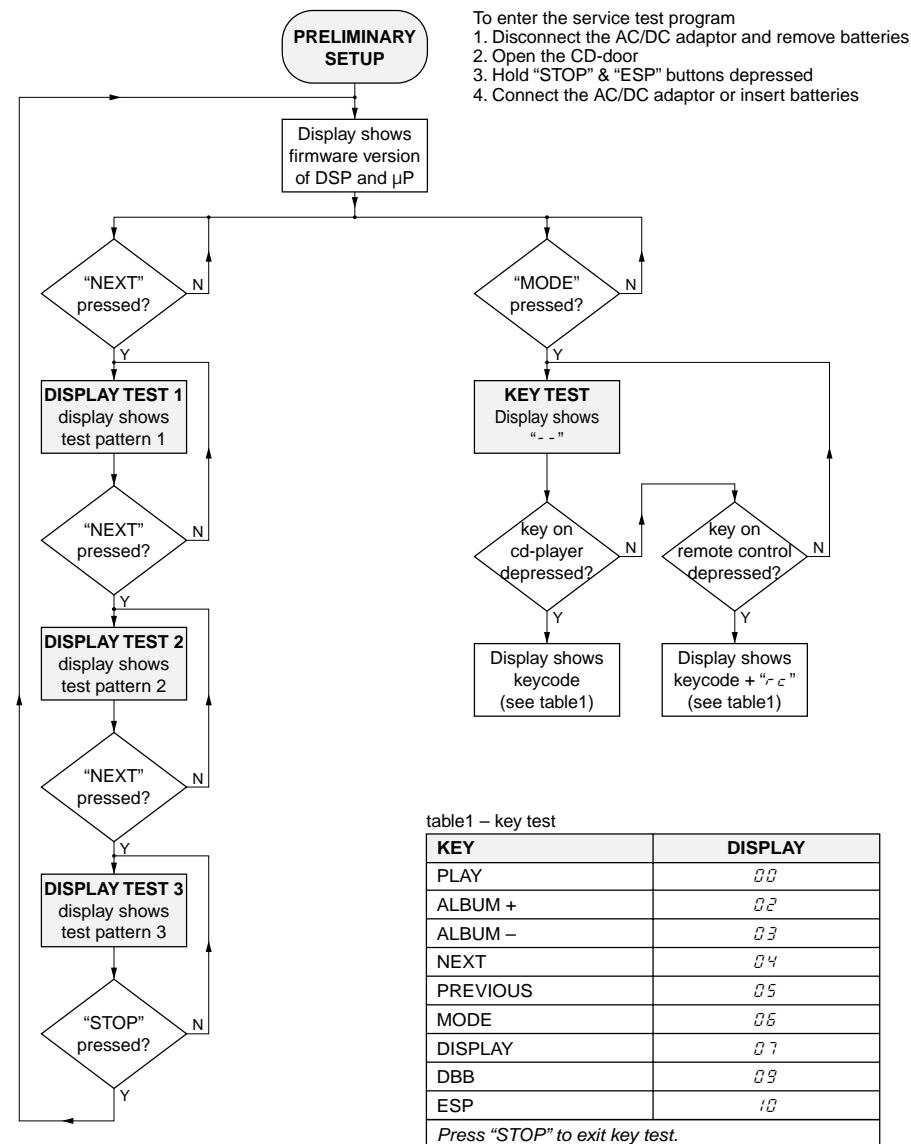
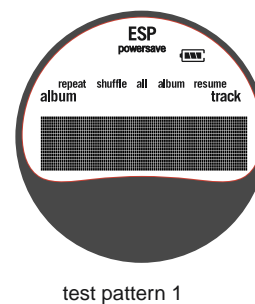

table1 – key test

KEY	DISPLAY
PLAY	00
ALBUM +	02
ALBUM -	03
NEXT	04
PREVIOUS	05
MODE	06
DISPLAY	07
DBB	09
ESP	10

Press "STOP" to exit key test.



test pattern 1

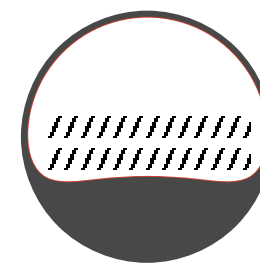

test pattern 2

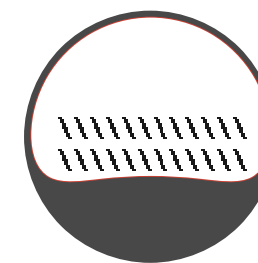

test pattern 3

BLOCKDIAGRAM

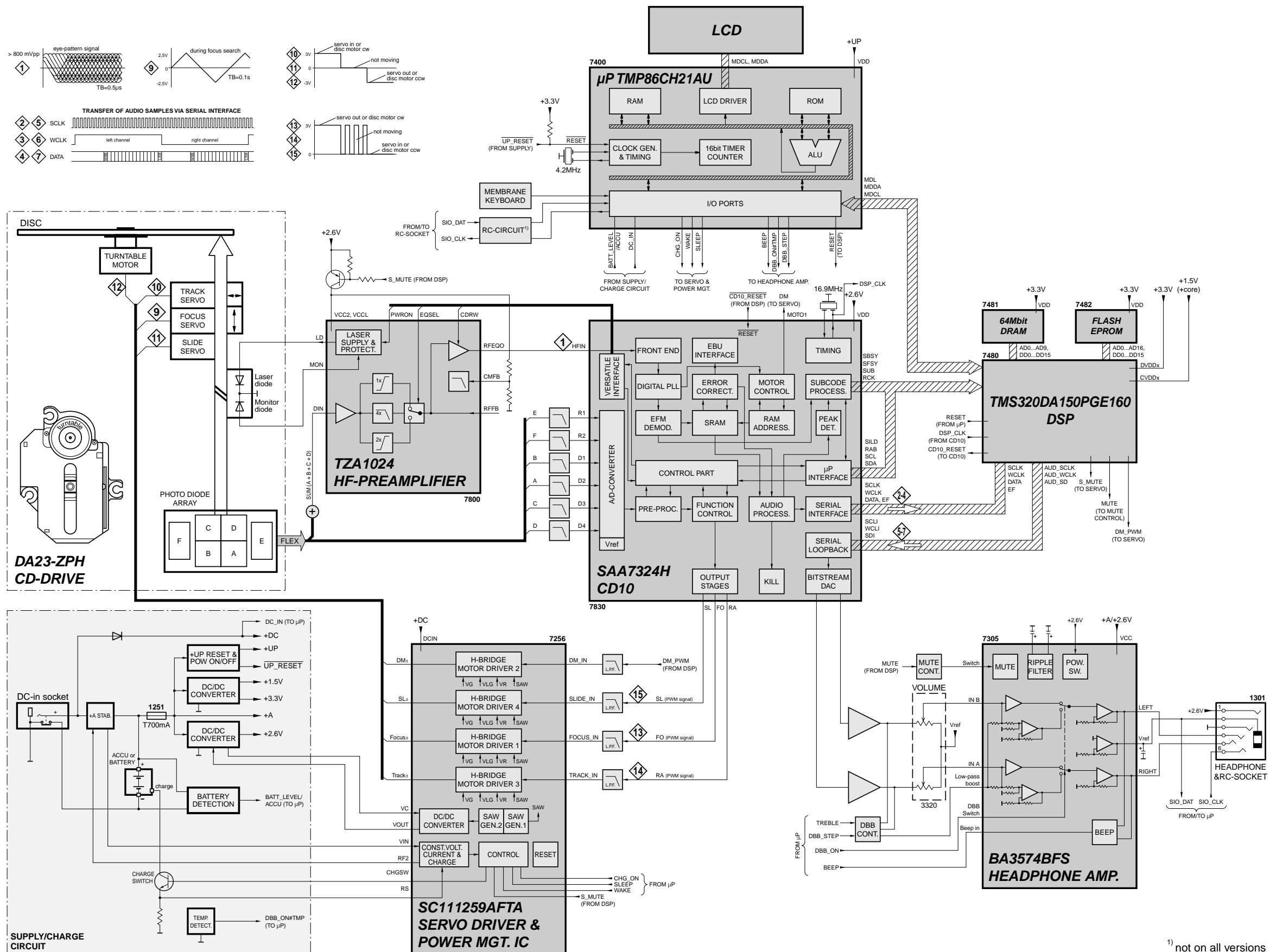

¹⁾ not on all versions

MAIN BOARD - CIRCUIT DIAGRAM

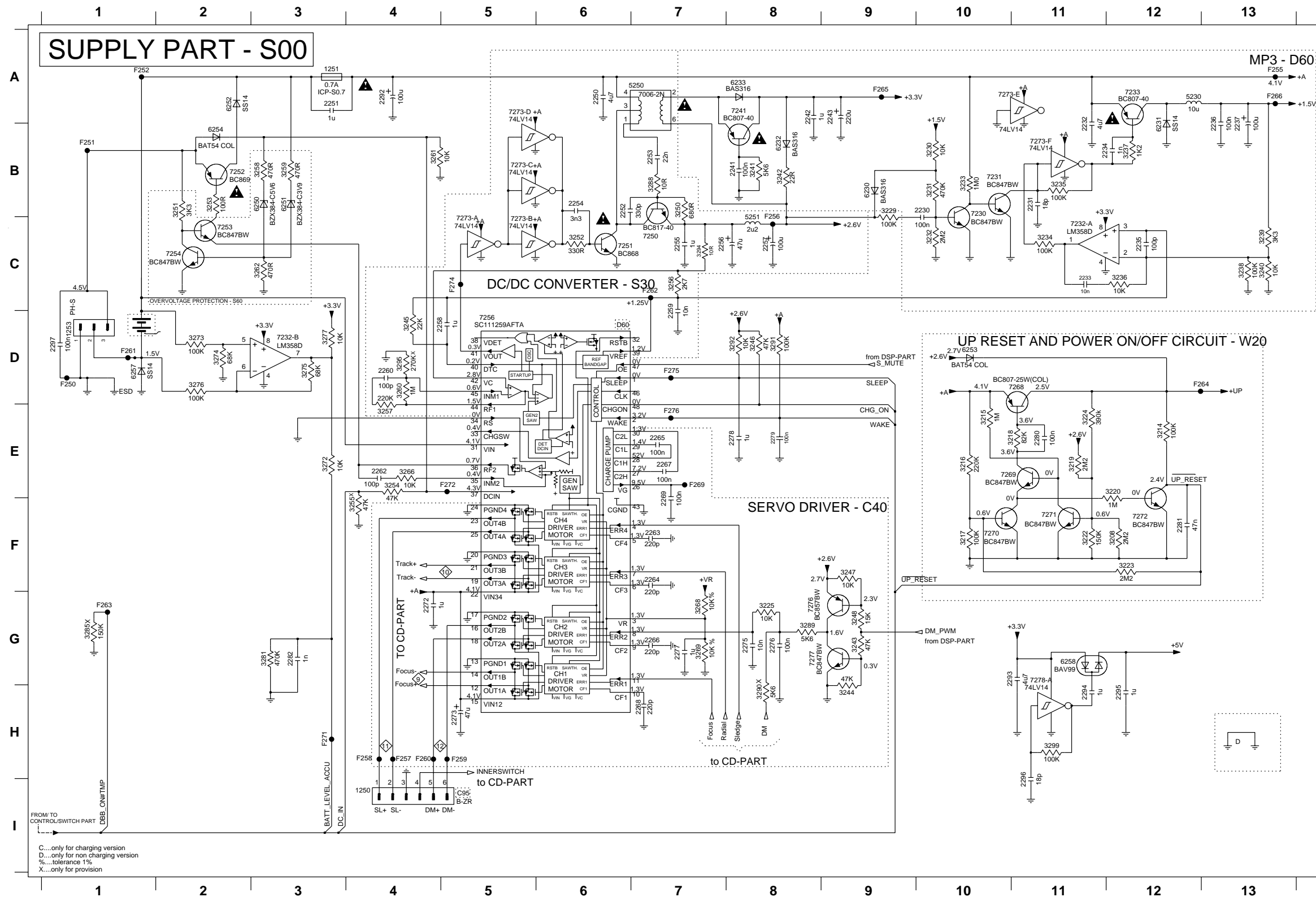

C...only for charging version
 D...only for non charging version
 %...tolerance 1%
 X...only for provision

1250 I4	3246 D8	F252 A1
1251 A3	3247 F9	F255 A13
1253 D1	3248 G9	F256 C8
2230 B10	3250 B7	F257 H4
2231 B11	3251 B2	F258 H4
2232 B11	3252 C6	F259 H5
2233 C11	3253 B2	F260 H4
2234 B12	3254 E4	F261 D1
2235 C12	3255 F4	F262 C7
2236 B13	3256 C7	F263 G1
2237 B13	3257 E4	F264 D12
2241 B8	3258 B3	F265 A9
2242 A8	3259 B3	F266 A13
2243 A9	3260 D4	F269 E7
2250 A6	3261 B4	F271 H3
2251 A3	3262 C3	F272 E5
2252 B6	3266 E4	F274 C5
2253 B7	3268 G7	F275 D7
2254 B6	3269 G7	F276 E7
2255 C7	3272 E3	
2256 C7	3273 D2	
2257 C8	3274 D2	
2258 D5	3275 D3	
2259 D7	3276 D2	
2260 D4	3277 D3	
2262 E4	3278 G3	
2263 F7	3285 G1	
2264 F7	3288 B7	
2265 E7	3289 G8	
2266 G7	3290 H8	
2267 E7	3291 D8	
2268 H7	3292 D8	
2269 F7	3294 C7	
2272 G4	3295 D4	
2273 H5	3299 H11	
2275 G8	5230 A12	
2276 G8	5250 A6	
2277 G7	5251 C8	
2278 E8	6230 B9	
2279 E8	6231 B12	
2280 E11	6232 B8	
2281 F12	6233 A8	
2282 G3	6250 B3	
2292 A4	6251 B3	
2293 G11	6252 A2	
2294 H11	6253 D10	
2295 H12	6254 B2	
2296 I11	6257 D1	
2297 D1	6258 G11	
3208 F12	7230 B10	
3214 E12	7231 B10	
3215 E10	7232-B D3	
3216 E10	7233 A12	
3217 F10	7241 A8	
3218 E11	7241 A8	
3219 E11	7250 C7	
3220 E12	7251 C6	
3222 F11	7252 B2	
3223 F12	7253 C2	
3224 E11	7254 C2	
3225 G8	7256 D5	
3230 B10	7268 D11	
3231 B10	7269 E11	
3232 C10	7270 F10	
3233 B10	7271 F11	
3234 C11	7272 F12	
3235 B11	7273-A C5	
3236 C12	7273-B C5	
3237 B12	7273-C B5	
3238 C13	7273-D A5	
3239 C13	7273-E A10	
3240 C13	7273-F B11	
3241 B8	7276 G8	
3242 B8	7277 G8	
3243 G9	7278-A G11	
3244 H9	F250 D1	
3245 D4	F251 B1	

MAIN BOARD - CIRCUIT DIAGRAM

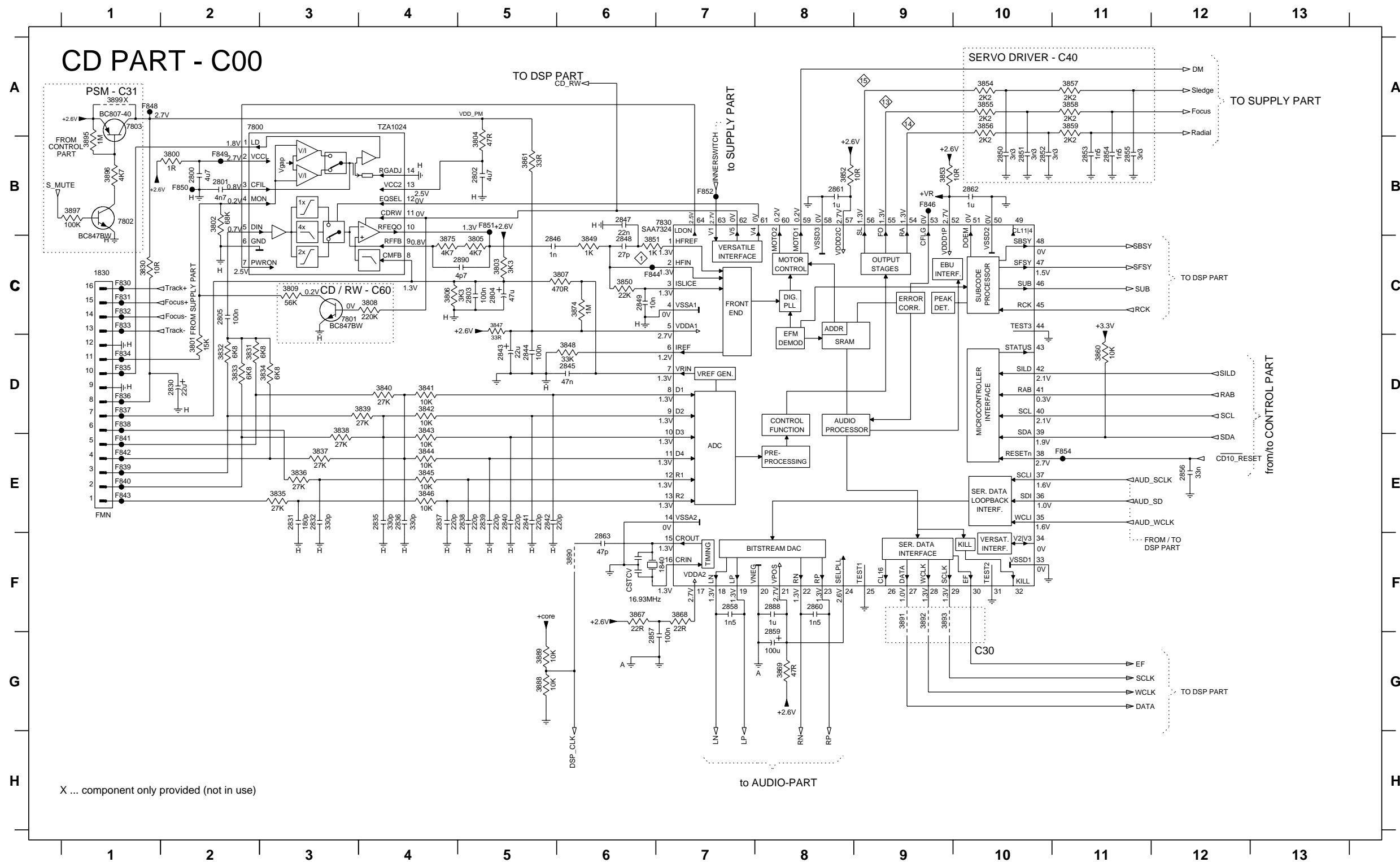

X ... component only provided (not in use)

1830 C1	3848 D6
1840 F7	3849 C6
2800 B2	3850 C6
2801 B2	3851 C6
2802 B5	3852 B8
2803 C5	3853 B9
2804 C5	3854 A10
2805 C2	3855 A10
2830 D2	3856 A10
2831 E3	3857 A11
2832 E3	3858 A11
2835 E4	3859 A11
2836 E4	3860 D11
2837 E4	3861 B5
2838 E5	3867 F6
2839 E5	3868 F7
2840 E5	3869 G8
2841 E5	3874 C6
2842 E5	3875 C4
2843 D5	3888 G5
2844 D5	3889 G5
2845 D6	3890 F6
2846 C5	3891 F9
2847 B6	3892 F9
2848 C6	3893 F9
2849 C6	3895 B1
2850 B10	3896 B1
2851 B10	3897 B1
2852 B10	3899 A1
2853 B11	7800 A2
2854 B11	7801 C3
2855 B11	7802 B1
2856 E12	7803 A1
2857 G6	7830 B6
2858 F7	F830 C1
2859 G8	F831 C1
2860 F8	F832 C1
2861 B8	F833 C1
2862 B10	F834 D1
2863 F6	F835 D1
2868 F8	F836 D1
2890 C5	F837 D1
3800 B2	F838 D1
3801 D2	F839 E1
3802 B2	F840 E1
3803 C5	F841 E1
3804 B5	F842 E1
3805 C5	F843 E1
3806 C4	F844 C6
3807 C6	F846 B9
3808 C4	F848 A1
3809 C3	F849 B2
3830 C1	F850 B2
3831 D2	F851 B5
3832 D2	F852 B7
3833 D2	F854 E11
3834 D3	
3835 E3	
3836 E3	
3837 E3	
3838 D3	
3839 D4	
3840 D4	
3841 D4	
3842 D4	
3843 D4	
3844 E4	
3845 E4	
3846 E4	
3847 C5	

MAIN BOARD - CIRCUIT DIAGRAM

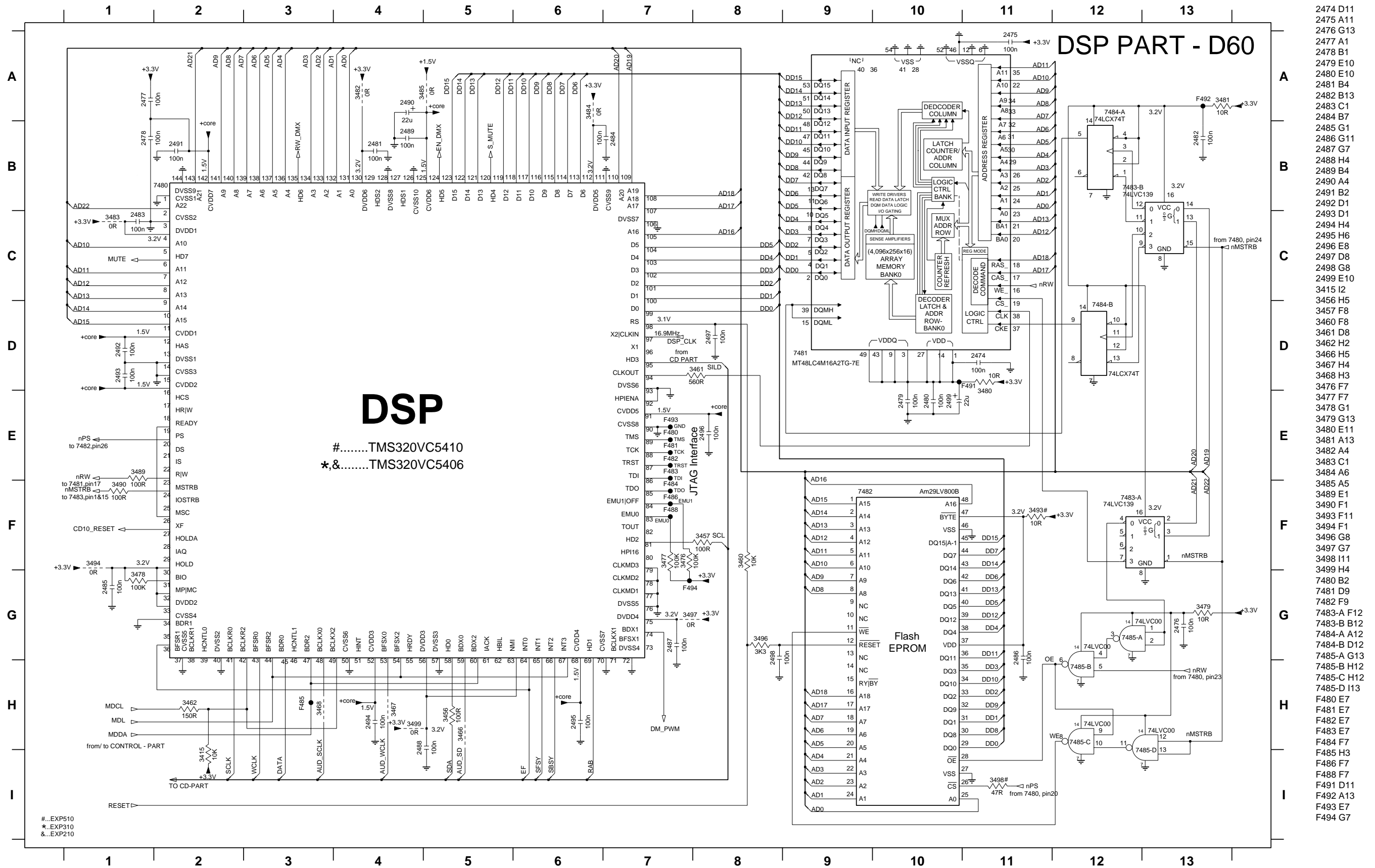

- 2474 D11
- 2475 A11
- 2476 G13
- 2477 A1
- 2478 B1
- 2479 E10
- 2480 E10
- 2481 B4
- 2482 B13
- 2483 C1
- 2484 B7
- 2485 G1
- 2486 G11
- 2487 G7
- 2488 H4
- 2489 B4
- 2490 A4
- 2491 B2
- 2492 D1
- 2493 D1
- 2494 H4
- 2495 H6
- 2496 E8
- 2497 D8
- 2498 G8
- 2499 E10
- 3415 I2
- 3456 H5
- 3457 F8
- 3460 F8
- 3461 D8
- 3462 H2
- 3466 H5
- 3467 H4
- 3468 H3
- 3476 F7
- 3477 F7
- 3478 G1
- 3479 G13
- 3480 E11
- 3481 A13
- 3482 A4
- 3483 C1
- 3484 A6
- 3485 A5
- 3489 E1
- 3490 F1
- 3493 F11
- 3494 F1
- 3496 G8
- 3497 G7
- 3498 I11
- 3499 H4
- 7480 B2
- 7481 D9
- 7482 F9
- 7483-A F12
- 7483-B B12
- 7484-A A12
- 7484-B D12
- 7485-A G13
- 7485-B H12
- 7485-C H12
- 7485-D I13
- F480 E7
- F481 E7
- F482 E7
- F483 E7
- F484 F7
- F485 H3
- F486 F7
- F488 F7
- F491 D11
- F492 A13
- F493 E7
- F494 G7

#...EXP510
 *...EXP310
 &...EXP210

MAIN BOARD - CIRCUIT DIAGRAM

1257 B13	2301 B2	2307 C4	2313 D9	2319 C11	2329 A10	3211 D5	3302 D2	3308 E2	3314 D4	3321 C12	3333 C4	3341 D3	7300-A D3	7306 C12	F304 D8	F310 D1	F320 C14
2238 D7	2302 D2	2308 D3	2314 D9	2320 B3	2330 A10	3212 E5	3303 C2	3309 C2	3315 B4	3324 E11	3334 D4	3342 B3	7300-B B3	7307 B10	F305 D14	F311 B1	F327 D14
2239 D5	2303 B2	2309 B3	2315 D9	2322 E11	2335 B13	3213 C7	3304 D2	3310 D4	3316 B8	3325 E10	3335 D8	3343 B11	7301 B4	7308 C6	F306 B8	F312 C1	
2240 E6	2304 D3	2310 B9	2316 E9	2323 E10	2336 E9	3293 C5	3305 B2	3311 C4	3317 B8	3327 B10	3336 A10	3346 E8	7302 D4	F300 D12	F307 C5	F313 B14	
2244 E5	2305 C3	2311 D8	2317 B10	2327 B9	3209 B7	3300 D2	3306 C4	3312 D4	3318 C11	3328 B10	3337 E8	3349 D11	7303 B8	F301 D12	F308 C5	F314 B13	
2300 D2	2306 D4	2312 D9	2318 C11	2328 B10	3210 C5	3301 B2	3307 C4	3313 B4	3319 E8	3329 B12	3338 D8	3350 C9	7305 C9	F302 C14	F309 D1	F316 C13	

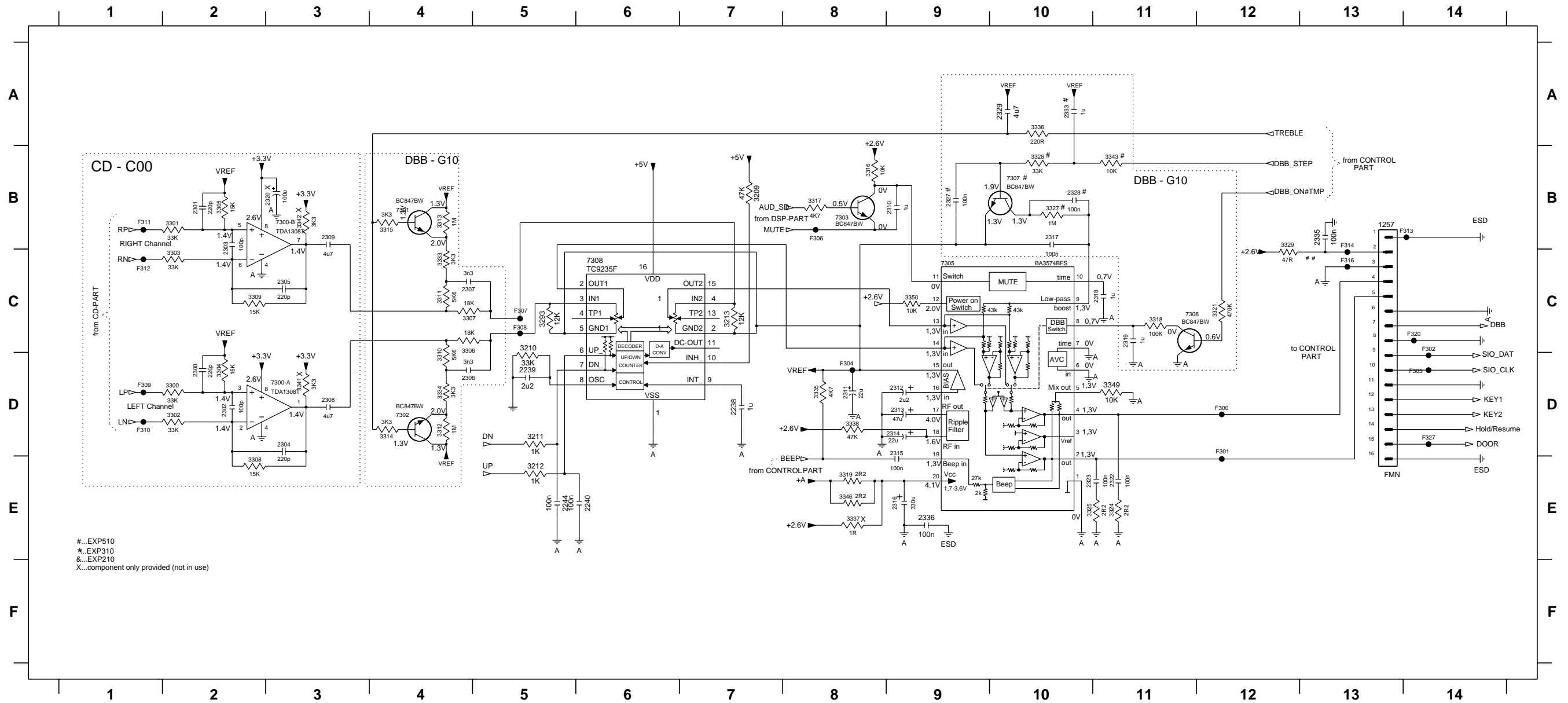

MAIN BOARD - CIRCUIT DIAGRAM

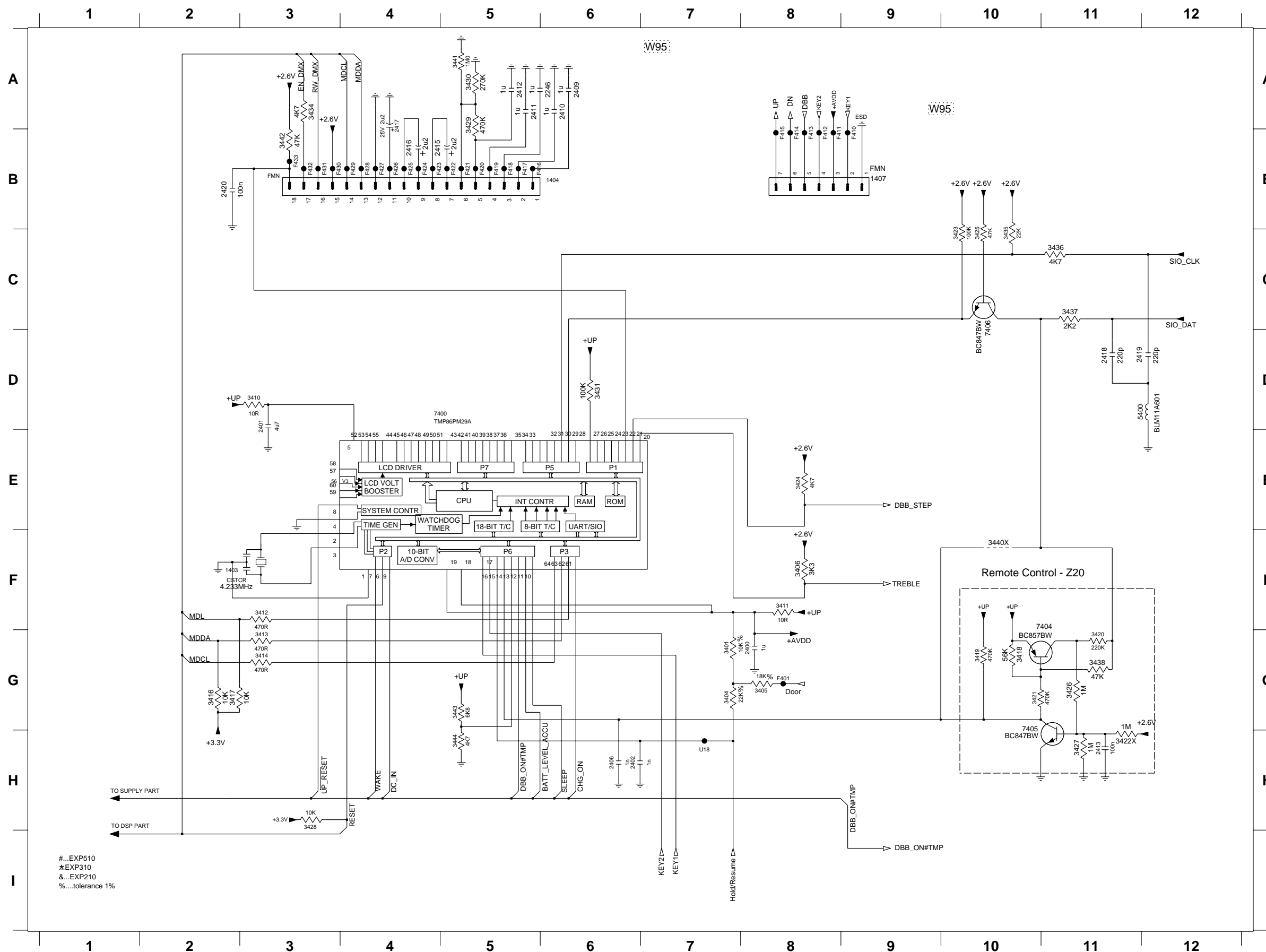

#...EXP510
 *EXP310
 &...EXP210
 %...tolerance 1%

- U18 H7
- 1403 F2
- 1404 B6
- 1407 B9
- 2246 A6
- 2400 G8
- 2401 D3
- 2402 H6
- 2406 H6
- 2409 A6
- 2410 A6
- 2411 A5
- 2412 A5
- 2413 H11
- 2415 B4
- 2416 B4
- 2417 A4
- 2418 D11
- 2419 D11
- 2420 B2
- 3401 G7
- 3404 G7
- 3405 G8
- 3406 F8
- 3410 D3
- 3411 F8
- 3412 F3
- 3413 G3
- 3414 G3
- 3416 G2
- 3417 G2
- 3418 G10
- 3419 G10
- 3420 G11
- 3421 G10
- 3422X H11
- 3423 C10
- 3424 E8
- 3425 C10
- 3426 G11
- 3427 H11
- 3428 H3
- 3429 A5
- 3430 A5
- 3431 D6
- 3434 A3
- 3435 C10
- 3436 C11
- 3437 C11
- 3438 G11
- 3440X F10
- 3441 A5
- 3442 B3
- 3443 G5
- 3444 H5
- 5400 D12
- 7400 D4
- 7404 F11
- 7405 G10
- 7406 C10
- F401 G8
- F410 B9
- F411 B8
- F412 B8
- F413 B8
- F414 B8
- F415 B8
- F416 B5
- F417 B5
- F418 B5
- F419 B5
- F420 B5
- F421 B5
- F422 B5
- F423 B4
- F424 B4
- F425 B4
- F426 B4
- F427 B4
- F428 B4
- F429 B4
- F430 B3
- F431 B3
- F432 B3
- F433 B3

MAIN BOARD - LAYOUT DIAGRAM
COPPER SIDE VIEW

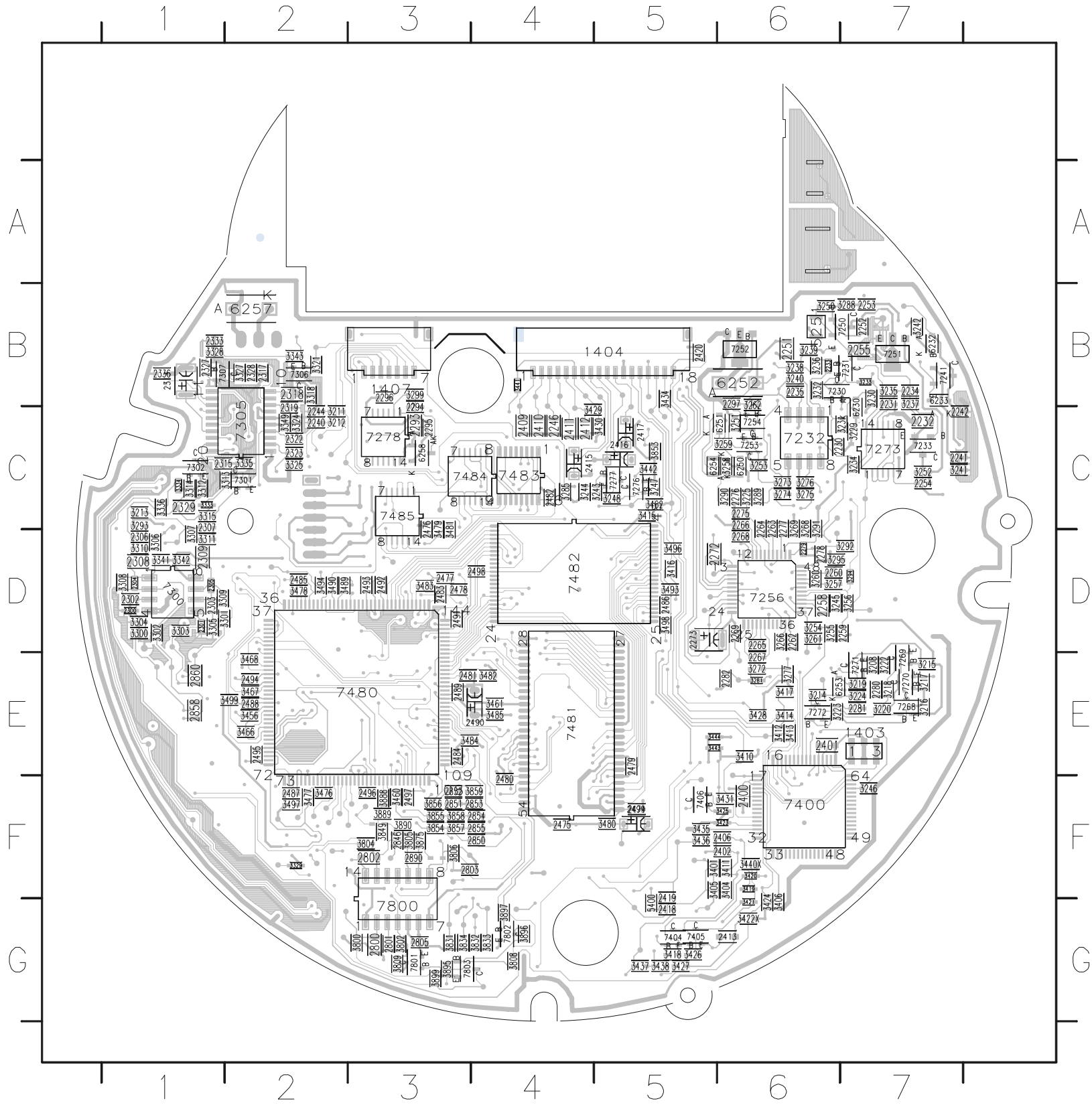

1404	7252	7253	7254	7255	7256	7257	7258	7259	7260	7261	7262	7263	7264	7265	7266	7267	7268	7269	7270	7271	7272	7273	7274	7275	7276	7277	7278	7279	7280	7281	7282	7283	7284	7285	7286	7287	7288	7289	7290	7291	7292	7293	7294	7295	7296	7297	7298	7299	7300	7301	7302	7303	7304	7305	7306	7307	7308	7309	7310	7311	7312	7313	7314	7315	7316	7317	7318	7319	7320	7321	7322	7323	7324	7325	7326	7327	7328	7329	7330	7331	7332	7333	7334	7335	7336	7337	7338	7339	7340	7341	7342	7343	7344	7345	7346	7347	7348	7349	7350	7351	7352	7353	7354	7355	7356	7357	7358	7359	7360	7361	7362	7363	7364	7365	7366	7367	7368	7369	7370	7371	7372	7373	7374	7375	7376	7377	7378	7379	7380	7381	7382	7383	7384	7385	7386	7387	7388	7389	7390	7391	7392	7393	7394	7395	7396	7397	7398	7399	7400	7401	7402	7403	7404	7405	7406	7407	7408	7409	7410	7411	7412	7413	7414	7415	7416	7417	7418	7419	7420	7421	7422	7423	7424	7425	7426	7427	7428	7429	7430	7431	7432	7433	7434	7435	7436	7437	7438	7439	7440	7441	7442	7443	7444	7445	7446	7447	7448	7449	7450	7451	7452	7453	7454	7455	7456	7457	7458	7459	7460	7461	7462	7463	7464	7465	7466	7467	7468	7469	7470	7471	7472	7473	7474	7475	7476	7477	7478	7479	7480	7481	7482	7483	7484	7485	7486	7487	7488	7489	7490	7491	7492	7493	7494	7495	7496	7497	7498	7499	7500	7501	7502	7503	7504	7505	7506	7507	7508	7509	7510	7511	7512	7513	7514	7515	7516	7517	7518	7519	7520	7521	7522	7523	7524	7525	7526	7527	7528	7529	7530	7531	7532	7533	7534	7535	7536	7537	7538	7539	7540	7541	7542	7543	7544	7545	7546	7547	7548	7549	7550	7551	7552	7553	7554	7555	7556	7557	7558	7559	7560	7561	7562	7563	7564	7565	7566	7567	7568	7569	7570	7571	7572	7573	7574	7575	7576	7577	7578	7579	7580	7581	7582	7583	7584	7585	7586	7587	7588	7589	7590	7591	7592	7593	7594	7595	7596	7597	7598	7599	7600	7601	7602	7603	7604	7605	7606	7607	7608	7609	7610	7611	7612	7613	7614	7615	7616	7617	7618	7619	7620	7621	7622	7623	7624	7625	7626	7627	7628	7629	7630	7631	7632	7633	7634	7635	7636	7637	7638	7639	7640	7641	7642	7643	7644	7645	7646	7647	7648	7649	7650	7651	7652	7653	7654	7655	7656	7657	7658	7659	7660	7661	7662	7663	7664	7665	7666	7667	7668	7669	7670	7671	7672	7673	7674	7675	7676	7677	7678	7679	7680	7681	7682	7683	7684	7685	7686	7687	7688	7689	7690	7691	7692	7693	7694	7695	7696	7697	7698	7699	7700	7701	7702	7703	7704	7705	7706	7707	7708	7709	7710	7711	7712	7713	7714	7715	7716	7717	7718	7719	7720	7721	7722	7723	7724	7725	7726	7727	7728	7729	7730	7731	7732	7733	7734	7735	7736	7737	7738	7739	7740	7741	7742	7743	7744	7745	7746	7747	7748	7749	7750	7751	7752	7753	7754	7755	7756	7757	7758	7759	7760	7761	7762	7763	7764	7765	7766	7767	7768	7769	7770	7771	7772	7773	7774	7775	7776	7777	7778	7779	7780	7781	7782	7783	7784	7785	7786	7787	7788	7789	7790	7791	7792	7793	7794	7795	7796	7797	7798	7799	7800	7801	7802	7803	7804	7805	7806	7807	7808	7809	7810	7811	7812	7813	7814	7815	7816	7817	7818	7819	7820	7821	7822	7823	7824	7825	7826	7827	7828	7829	7830	7831	7832	7833	7834	7835	7836	7837	7838	7839	7840	7841	7842	7843	7844	7845	7846	7847	7848	7849	7850	7851	7852	7853	7854	7855	7856	7857	7858	7859	7860	7861	7862	7863	7864	7865	7866	7867	7868	7869	7870	7871	7872	7873	7874	7875	7876	7877	7878	7879	7880	7881	7882	7883	7884	7885	7886	7887	7888	7889	7890	7891	7892	7893	7894	7895	7896	7897	7898	7899	7900	7901	7902	7903	7904	7905	7906	7907	7908	7909	7910	7911	7912	7913	7914	7915	7916	7917	7918	7919	7920	7921	7922	7923	7924	7925	7926	7927	7928	7929	7930	7931	7932	7933	7934	7935	7936	7937	7938	7939	7940	7941	7942	7943	7944	7945	7946	7947	7948	7949	7950	7951	7952	7953	7954	7955	7956	7957	7958	7959	7960	7961	7962	7963	7964	7965	7966	7967	7968	7969	7970	7971	7972	7973	7974	7975	7976	7977	7978	7979	7980	7981	7982	7983	7984	7985	7986	7987	7988	7989	7990	7991	7992	7993	7994	7995	7996	7997	7998	7999	8000
------	------	------	------	------	------	------	------	------	------	------	------	------	------	------	------	------	------	------	------	------	------	------	------	------	------	------	------	------	------	------	------	------	------	------	------	------	------	------	------	------	------	------	------	------	------	------	------	------	------	------	------	------	------	------	------	------	------	------	------	------	------	------	------	------	------	------	------	------	------	------	------	------	------	------	------	------	------	------	------	------	------	------	------	------	------	------	------	------	------	------	------	------	------	------	------	------	------	------	------	------	------	------	------	------	------	------	------	------	------	------	------	------	------	------	------	------	------	------	------	------	------	------	------	------	------	------	------	------	------	------	------	------	------	------	------	------	------	------	------	------	------	------	------	------	------	------	------	------	------	------	------	------	------	------	------	------	------	------	------	------	------	------	------	------	------	------	------	------	------	------	------	------	------	------	------	------	------	------	------	------	------	------	------	------	------	------	------	------	------	------	------	------	------	------	------	------	------	------	------	------	------	------	------	------	------	------	------	------	------	------	------	------	------	------	------	------	------	------	------	------	------	------	------	------	------	------	------	------	------	------	------	------	------	------	------	------	------	------	------	------	------	------	------	------	------	------	------	------	------	------	------	------	------	------	------	------	------	------	------	------	------	------	------	------	------	------	------	------	------	------	------	------	------	------	------	------	------	------	------	------	------	------	------	------	------	------	------	------	------	------	------	------	------	------	------	------	------	------	------	------	------	------	------	------	------	------	------	------	------	------	------	------	------	------	------	------	------	------	------	------	------	------	------	------	------	------	------	------	------	------	------	------	------	------	------	------	------	------	------	------	------	------	------	------	------	------	------	------	------	------	------	------	------	------	------	------	------	------	------	------	------	------	------	------	------	------	------	------	------	------	------	------	------	------	------	------	------	------	------	------	------	------	------	------	------	------	------	------	------	------	------	------	------	------	------	------	------	------	------	------	------	------	------	------	------	------	------	------	------	------	------	------	------	------	------	------	------	------	------	------	------	------	------	------	------	------	------	------	------	------	------	------	------	------	------	------	------	------	------	------	------	------	------	------	------	------	------	------	------	------	------	------	------	------	------	------	------	------	------	------	------	------	------	------	------	------	------	------	------	------	------	------	------	------	------	------	------	------	------	------	------	------	------	------	------	------	------	------	------	------	------	------	------	------	------	------	------	------	------	------	------	------	------	------	------	------	------	------	------	------	------	------	------	------	------	------	------	------	------	------	------	------	------	------	------	------	------	------	------	------	------	------	------	------	------	------	------	------	------	------	------	------	------	------	------	------	------	------	------	------	------	------	------	------	------	------	------	------	------	------	------	------	------	------	------	------	------	------	------	------	------	------	------	------	------	------	------	------	------	------	------	------	------	------	------	------	------	------	------	------	------	------	------	------	------	------	------	------	------	------	------	------	------	------	------	------	------	------	------	------	------	------	------	------	------	------	------	------	------	------	------	------	------	------	------	------	------	------	------	------	------	------	------	------	------	------	------	------	------	------	------	------	------	------	------	------	------	------	------	------	------	------	------	------	------	------	------	------	------	------	------	------	------	------	------	------	------	------	------	------	------	------	------	------	------	------	------	------	------	------	------	------	------	------	------	------	------	------	------	------	------	------	------	------	------	------	------	------	------	------	------	------	------	------	------	------	------	------	------	------	------	------	------	------	------	------	------	------	------	------	------	------	------	------	------	------	------	------	------	------	------	------	------	------	------	------	------	------	------	------	------	------	------	------	------	------	------	------	------

JACK BOARD - CIRCUIT DIAGRAM

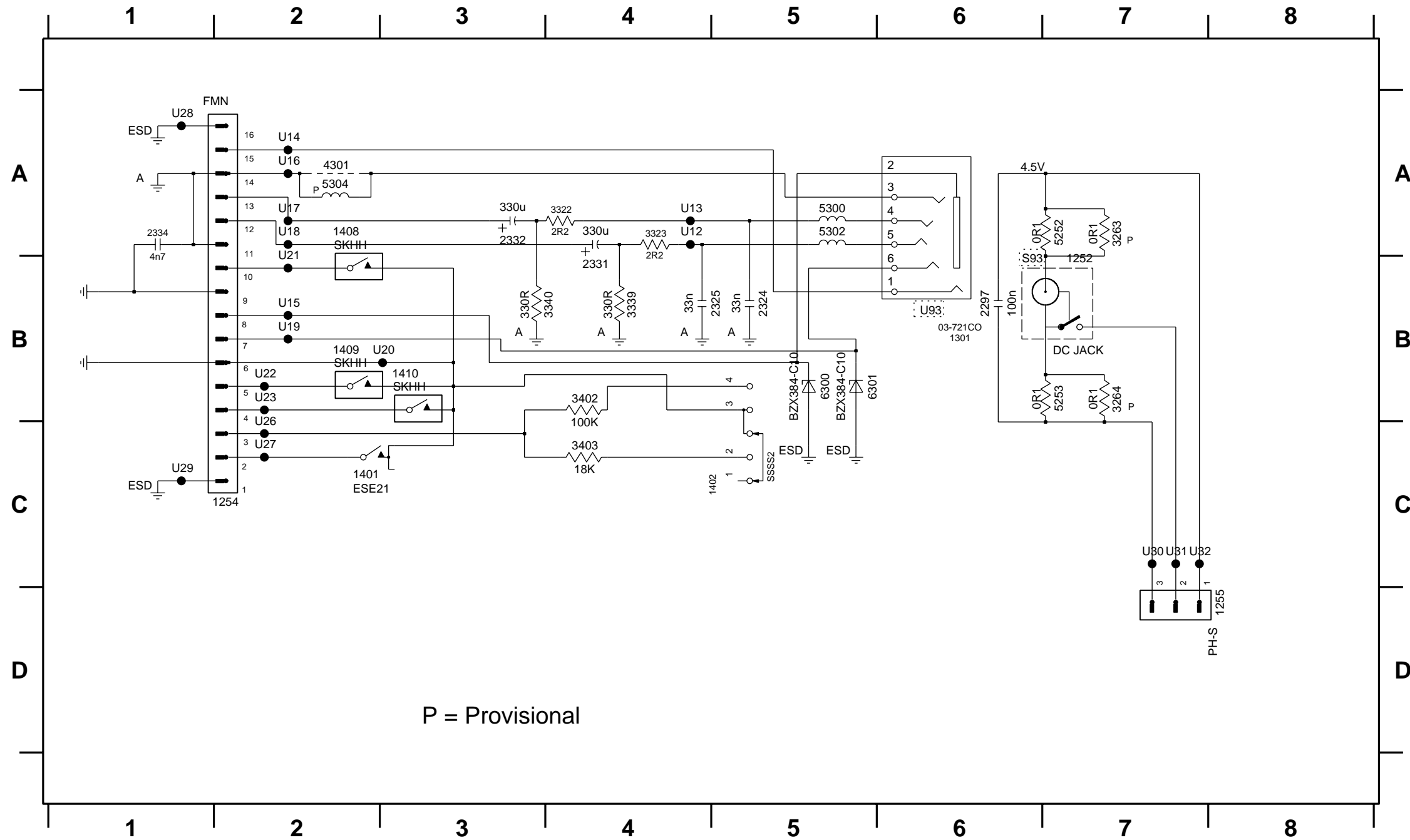

- U12 A4
- U13 A4
- U14 A2
- U15 B2
- U16 A2
- U17 A2
- U18 A2
- U19 B2
- U20 B3
- U21 B2
- U22 B2
- U23 B2
- U26 C2
- U27 C2
- U28 A1
- U29 C1
- U30 C7
- U31 C7
- U32 C7
- 1252 B7
- 1254 C2
- 1255 D8
- 1301 B6
- 1401 C2
- 1402 C4
- 1408 A2
- 1409 B2
- 1410 B3
- 2297 B6
- 2324 B5
- 2325 B4
- 2331 B4
- 2332 A3
- 2334 A1
- 3263 A7
- 3264 B7
- 3322 A4
- 3323 A4
- 3339 B4
- 3340 B3
- 3402 B4
- 3403 C4
- 4301 A2
- 5252 A7
- 5253 B7
- 5300 A5
- 5302 A5
- 5304 A2
- 6300 B5
- 6301 B5

JACK BOARD - LAYOUT DIAGRAM
COPPER SIDE VIEW

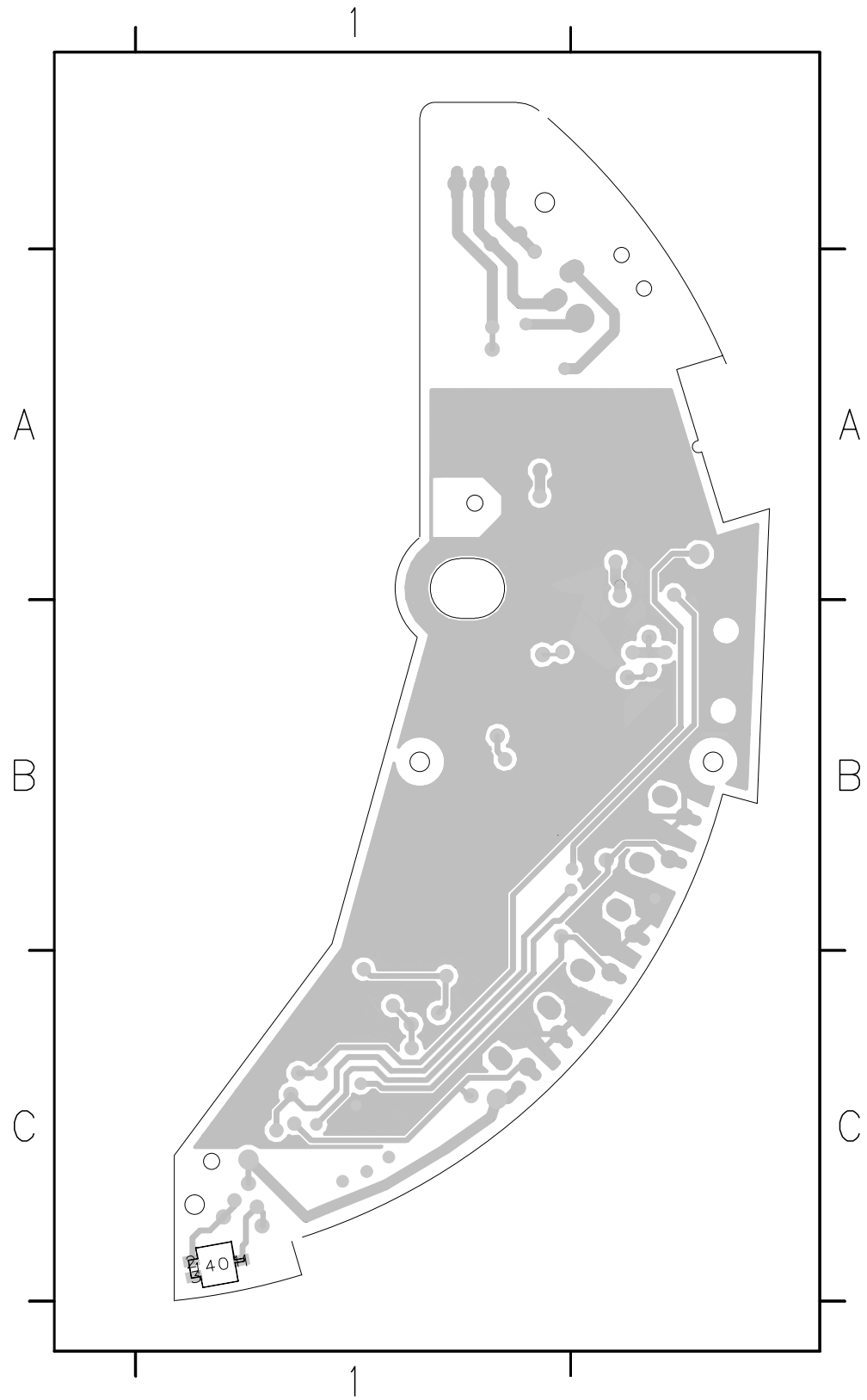

1401 C1

JACK BOARD - LAYOUT DIAGRAM
COMPONENT SIDE VIEW



1252	A1
1254	C2
1255	A1
1301	A1
1402	B1
1408	B1
1409	C1
1410	A1
2207	A1
2204	B1
2325	B1
2331	B1
2332	B1
2334	C2
2333	A1
2334	A1
2336	A1
2339	B1
3402	B1
3403	B1
3404	A1
3501	A1
3502	A1
3503	A1
3504	A1
3500	A1
3502	A1
3504	A1
3500	A1
6301	A1

EXPLODED VIEW DIAGRAM - CABINET

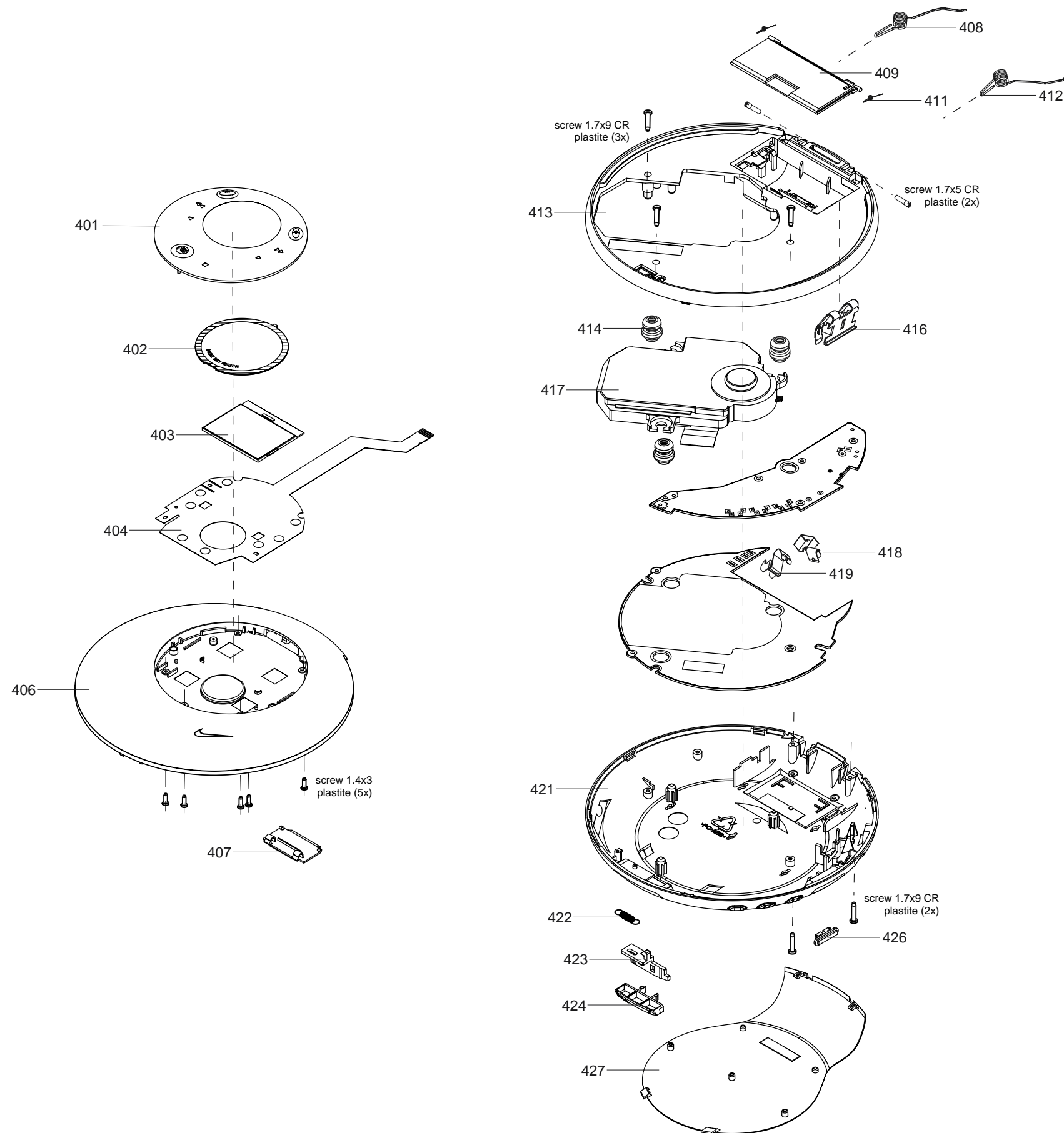

MECHANICAL PARTSLIST - CABINET

401	3140 114 45210	CD-LENS-KEYPAD
402	3140 113 23160	INLAY-LCD
403	3140 110 51600	LCD
404	3140 113 32940	MEMBRANE-KEYBOARD
406	3140 117 63550	CD-DOOR-ASSY
407	3140 114 45200	PLATE-SUPPORTING
408	3140 111 01300	SPRING-DOOR-L
409	3140 114 45190	DOOR-BATTERY
411	3140 111 01320	SPRING-BATTERY-DOOR
412	3140 111 01310	SPRING-DOOR-R
413	3140 117 63570	MIDDLE-CAB-ASSY
414	3103 304 69590	SUSPENSION
416	3140 111 22240	CONTACT-PLATE-SHORT
417	3103 309 05480	CD DA23ZPH
418	3140 111 22200	CONTACT-PLATE-PLUS
419	3140 111 22210	CONTACT-PLATE-MINUS
421	3140 117 63560	BOTTOM-CAB-ASSY
422	3140 111 01290	SPRING-SLIDER
423	3140 114 45650	LOCK-SLIDER
424	3140 114 45640	BUTTON-SLIDER
426	3140 114 45160	KNOB-SLIDE-SW
427	3140 114 45220	PLATE-DECORATION
	3140 110 40900	SCREW-CD DOOR HINGE
	3103 300 41610	SCREW-P-1,4X3-NI

Note: Only these parts mentioned in the list are normal service parts.

ELECTRICAL PARTSLIST - MAIN BOARD**- MISCELLANEOUS -**

1250	2422 025 12272	CONNECTOR 6P
1251	2422 086 11012	FUSE 0,7A 50V
1257	4822 267 11027	CONNECTOR 16P
1403	2422 540 98536	RESISTOR 4,23MHZ
1404	2422 025 17567	FFC CONNECTOR 18P
1407	2422 025 16806	FFC CONNECTOR 7P
1830	4822 267 11027	CONNECTOR 16P
1840	4822 242 10989	FILTER

- CAPACITORS -

2230	2238 586 59812	100nF +80-20% Y5V 50V
2231	4822 126 14507	18pF 5% NP0 50V
2232	2020 552 96305	4,7µF +80-20% Y5V 10V
2233	2238 586 59812	100nF +80-20% Y5V 50V
2234	5322 126 11578	1nF 10% X7R 50V
2235	2020 552 94427	100pF 5% NP0 50V
2236	2238 586 59812	100nF +80-20% Y5V 50V
2237	3198 032 15190	100µF 20% 4V
2238	4822 126 14472	1µF 10% X7R 10V
2239	5322 126 14103	2,2µF +80-20% Y5V 10V
2240	2238 586 59812	100nF +80-20% Y5V 50V
2241	2238 586 59812	100nF +80-20% Y5V 50V
2242	3198 017 41050	1µF Y5V 10V
2243	4822 124 81059	220µF 20% 4V
2244	2238 586 59812	100nF +80-20% Y5V 50V
2246	4822 126 14472	1µF 10% X7R 10V
2250	2020 552 96305	4,7µF +80-20% Y5V 10V
2251	4822 126 14472	1µF 10% X7R 10V
2252	4822 126 14241	330pF NP0 50V
2253	4822 126 14494	22nF 10% X7R 25V
2254	5322 126 11579	3,3nF 10% X7R 63V
2255	4822 126 14472	1µF 10% X7R 10V
2256	2022 009 00656	47µF 20% 6,3V
2257	3198 032 15190	100µF 20% 4V
2258	4822 126 14472	1µF 10% X7R 10V
2259	5322 126 11583	10nF 10% X7R 50V
2260	2020 552 94427	100pF 5% NP0 50V
2261	2238 586 59812	100nF +80-20% Y5V 50V
2262	2020 552 94427	100pF 5% NP0 50V
2263	4822 126 13883	220pF 5% 50V
2264	4822 126 13883	220pF 5% 50V
2265	2238 586 59812	100nF +80-20% Y5V 50V
2266	4822 126 13883	220pF 5% 50V
2267	2238 586 59812	100nF +80-20% Y5V 50V
2268	4822 126 13883	220pF 5% 50V
2269	2238 586 59812	100nF +80-20% Y5V 50V
2272	4822 126 14472	1µF 10% X7RM 10V
2273	2022 009 00656	47µF 20% 6,3V
2275	5322 126 11583	10nF 10% X7R 50V
2276	2238 586 59812	100nF +80-20% Y5V 50V

- CAPACITORS -

2277	3198 017 41050	1µF Y5V 10V
2278	3198 017 41050	1µF Y5V 10V
2280	2238 586 59812	100nF +80-20% Y5V 50V
2281	3198 017 34730	47nF X7R 16V
2282	5322 126 11578	1nF 10% X7R 50V
2292	4822 124 12095	100µF 20% 16V
2293	2020 552 96305	4,7µF +80-20% Y5V 10V
2294	3198 017 41050	1µF Y5V 10V
2295	3198 017 41050	1µF Y5V 10V
2296	4822 126 14507	18pF 5% NP0 50V
2300	4822 126 13883	220pF 5% 50V
2301	4822 126 13883	220pF 5% 50V
2302	2020 552 94427	100pF 5% NP0 50V
2303	2020 552 94427	100pF 5% NP0 50V
2304	4822 126 13883	220pF 5% 50V
2305	4822 126 13883	220pF 5% 50V
2306	5322 126 11579	3,3nF 10% X7R 63V
2307	5322 126 11579	3,3nF 10% X7R 63V
2308	2020 552 96305	4,7µF +80-20% Y5V 10V
2309	2020 552 96305	4,7µF +80-20% Y5V 10V
2310	4822 126 14472	1µF 10% X7R 10V
2311	4822 124 12313	22µF 10V 20%
2312	3198 032 75090	2,2µF 20% 35V
2313	2022 009 00656	47µF 20% 6,3V
2314	4822 124 12313	22µF 10V 20%
2315	2238 586 59812	100nF +80-20% Y5V 50V
2316	4822 124 12397	330µF 20% 6,3V
2317	2238 586 59812	100nF +80-20% Y5V 50V
2318	4822 126 14472	1µF 10% X7R 10V
2319	3198 017 41050	1µF Y5V 10V
2322	2238 586 59812	100nF +80-20% Y5V 50V
2323	2238 586 59812	100nF +80-20% Y5V 50V
2327	2238 586 59812	100nF +80-20% Y5V 50V
2328	2238 586 59812	100nF +80-20% Y5V 50V
2333	3198 017 41050	1µF Y5V 10V
2334	4822 126 13193	4,7nF 10% X7R 63V
2335	2238 586 59812	100nF +80-20% Y5V 50V
2400	4822 126 14472	1µF 10% X7R 10V
2401	2020 552 96305	4,7µF +80-20% Y5V 10V
2402	5322 126 11578	1nF 10% X7R 50V
2409	4822 126 14472	1µF 10% X7R 10V
2410	4822 126 14472	1µF 10% X7R 10V
2411	4822 126 14472	1µF 10% X7R 10V
2412	4822 126 14472	1µF 10% X7R 10V
2413	2238 586 59812	100nF +80-20% Y5V 50V
2415	3198 032 64090	2,2µF 20% 25V
2416	3198 032 64090	2,2µF 20% 25V
2417	3198 032 64090	2,2µF 20% 25V
2418	4822 126 13883	220pF 5% 50V
2419	4822 126 13883	220pF 5% 50V

ELECTRICAL PARTSLIST - MAIN BOARD**- CAPACITORS -**

2474	2238 586 59812	100nF +80-20% Y5V 50V
2475	2238 586 59812	100nF +80-20% Y5V 50V
2476	2238 586 59812	100nF +80-20% Y5V 50V
2477	2238 586 59812	100nF +80-20% Y5V 50V
2478	2238 586 59812	100nF +80-20% Y5V 50V
2479	2238 586 59812	100nF +80-20% Y5V 50V
2480	2238 586 59812	100nF +80-20% Y5V 50V
2481	2238 586 59812	100nF +80-20% Y5V 50V
2482	2238 586 59812	100nF +80-20% Y5V 50V
2483	2238 586 59812	100nF +80-20% Y5V 50V
2484	2238 586 59812	100nF +80-20% Y5V 50V
2485	2238 586 59812	100nF +80-20% Y5V 50V
2486	2238 586 59812	100nF +80-20% Y5V 50V
2487	2238 586 59812	100nF +80-20% Y5V 50V
2488	2238 586 59812	100nF +80-20% Y5V 50V
2489	2238 586 59812	100nF +80-20% Y5V 50V
2490	4822 124 11946	22µF 20% 16V
2491	2238 586 59812	100nF +80-20% Y5V 50V
2492	2238 586 59812	100nF +80-20% Y5V 50V
2493	2238 586 59812	100nF +80-20% Y5V 50V
2494	2238 586 59812	100nF +80-20% Y5V 50V
2495	2238 586 59812	100nF +80-20% Y5V 50V
2496	2238 586 59812	100nF +80-20% Y5V 50V
2497	2238 586 59812	100nF +80-20% Y5V 50V
2498	2238 586 59812	100nF +80-20% Y5V 50V
2499	4822 124 11946	22µF 20% 16V
2800	2020 552 96305	4,7µF +80-20% Y5V 10V
2801	4822 126 13193	4,7nF 10% X7R 63V
2802	2020 552 96305	4,7µF +80-20% Y5V 10V
2803	2238 586 59812	100nF +80-20% Y5V 50V
2804	2022 009 00656	47µF 20% 6,3V
2805	2238 586 59812	100nF +80-20% Y5V 50V
2830	4822 124 11946	22µF 20% 16V
2831	4822 126 14508	180pF 5% NP0 50V
2832	4822 126 14241	330pF NP0 50V
2835	4822 126 14241	330pF NP0 50V
2836	4822 126 14241	330pF NP0 50V
2837	4822 126 13883	220pF 5% 50V
2838	4822 126 13883	220pF 5% 50V
2839	4822 126 13883	220pF 5% 50V
2840	4822 126 13883	220pF 5% 50V
2841	4822 126 13883	220pF 5% 50V
2842	4822 126 13883	220pF 5% 50V
2843	4822 124 11946	22µF 20% 16V
2844	2238 586 59812	100nF +80-20% Y5V 50V
2845	3198 017 34730	47nF X7R 16V
2846	5322 126 11578	1nF 10% X7R 50V
2847	4822 126 14494	22nF 10% X7R 25V
2848	4822 126 11669	27pF
2849	5322 126 11583	10nF 10% X7R 50V

- CAPACITORS -

2850	5322 126 11579	3,3nF 10% X7R 63V
2851	5322 126 11579	3,3nF 10% X7R 63V
2852	5322 126 11579	3,3nF 10% X7R 63V
2853	4822 126 14247	1,5nF X7R 50V
2854	4822 126 14247	1,5nF X7R 50V
2855	5322 126 11579	3,3nF 10% X7R 63V
2856	4822 126 14549	33nF 16V X7R
2857	2238 586 59812	100nF +80-20% Y5V 50V
2858	4822 126 13344	1,5nF 5% 63V
2859	2022 009 00656	47µF 20% 6,3V
2860	4822 126 13344	1,5nF 5% 63V
2861	3198 017 41050	1µF Y5V 10V
2862	3198 017 41050	1µF Y5V 10V
2863	4822 126 11785	47pF 5% NP0 50V
2888	2238 586 59812	100nF +80-20% Y5V 50V
2890	4822 126 13887	4,7pF 50V

- RESISTORS -

3208	3198 021 32250	2,2M 5%
3209	4822 117 12925	47K 1% 0,063W
3210	4822 051 30333	33K 5% 0,062W
3211	4822 051 30102	1K 5% 0,062W
3212	4822 051 30102	1K 5% 0,062W
3214	4822 117 13632	100K 1% 0,62W
3215	4822 051 30105	1M 5% 0,062W
3216	4822 117 12891	220K 1%
3217	4822 117 13632	100K 1% 0,62W
3218	4822 117 12864	82K 5% 0,6W
3219	3198 021 32250	2,2M 5%
3220	4822 051 30105	1M 5% 0,062W
3222	4822 051 30154	150K 5% 0,062W
3223	3198 021 32250	2,2M 5%
3224	4822 051 30474	470K 5% 0,062W
3225	4822 051 30103	10K 5% 0,062W
3230	4822 051 30103	10K 5% 0,062W
3231	4822 051 30334	330K 5% 0,062W
3232	3198 021 32250	2,2M 5%
3233	4822 051 30474	470K 5% 0,062W
3234	4822 117 13632	100K 1% 0,62W
3235	4822 117 13632	100K 1% 0,62W
3236	4822 051 30103	10K 5% 0,062W
3237	4822 117 11817	1,2K 1% 1/16W
3238	4822 117 13632	100K 1% 0,62W
3239	4822 051 30332	3,3K 5% 0,062W
3240	4822 051 30103	10K 5% 0,062W
3241	4822 051 30562	5,6K 5% 0,063W
3242	4822 117 12139	22R 5% 0,062W
3243	4822 117 12925	47K 1% 0,063W

ELECTRICAL PARTSLIST - MAIN BOARD**- RESISTORS -**

3244	4822 117 12925	47K 1% 0,063W
3245	4822 051 30223	22K 5% 0,062W
3246	4822 117 12925	47K 1% 0,063W
3247	4822 051 30103	10K 5% 0,062W
3248	4822 051 30153	15K 5% 0,062W
3250	4822 051 30681	680R 5% 0,062W
3251	4822 051 30332	3,3K 5% 0,062W
3252	4822 051 30331	330R 5% 0,062W
3253	4822 051 30101	1R 5% 0,062W
3254	4822 117 12925	47K 1% 0,063W
3256	4822 051 30272	2,7K 5% 0,062W
3257	4822 117 12891	220K 1%
3258	4822 051 30471	470R 5% 0,062W
3259	4822 051 30471	470R 5% 0,062W
3260	4822 051 30105	1M 5% 0,062W
3261	4822 051 30103	10K 5% 0,062W
3262	4822 051 30471	470R 5% 0,062W
3266	4822 051 30103	10K 5% 0,062W
3268	2120 108 93942	10K 1%
3269	2120 108 93942	10K 1%
3272	4822 051 30103	10K 5% 0,062W
3273	4822 117 13632	100K 1% 0,62W
3274	2120 108 93057	68K 1%
3275	2120 108 93057	68K 1%
3276	4822 117 13632	100K 1% 0,62W
3277	4822 051 30103	10K 5% 0,062W
3281	4822 117 12891	220K 1%
3288	4822 051 30109	10R 5% 0,062W
3289	4822 051 30562	5,6K 5% 0,063W
3291	4822 117 13632	100K 1% 0,62W
3292	4822 051 30103	10K 5% 0,062W
3293	4822 051 30123	12K 5% 0,062W
3294	4822 051 30123	12K 5% 0,062W
3299	4822 117 13632	100K 1% 0,62W
3300	4822 051 30333	33K 5% 0,062W
3301	4822 051 30333	33K 5% 0,062W
3302	4822 051 30333	33K 5% 0,062W
3303	4822 051 30333	33K 5% 0,062W
3304	4822 051 30153	15K 5% 0,062W
3305	4822 051 30153	15K 5% 0,062W
3306	4822 051 30183	18K 5% 0,062W
3307	4822 051 30183	18K 5% 0,062W
3308	4822 051 30153	15K 5% 0,062W
3309	4822 051 30153	15K 5% 0,062W
3310	4822 051 30562	5,6K 5% 0,063W
3311	4822 051 30562	5,6K 5% 0,063W
3312	4822 051 30105	1M 5% 0,062W
3313	4822 051 30105	1M 5% 0,062W
3314	4822 051 30332	3,3K 5% 0,062W
3315	4822 051 30332	3,3K 5% 0,062W

- RESISTORS -

3316	4822 051 30103	10K 5% 0,062W
3317	4822 051 30472	4,7K 5% 0,062W
3318	4822 117 13632	100K 1% 0,62W
3319	4822 117 13613	2,2R 5%
3321	4822 051 30474	470K 5% 0,062W
3324	4822 117 13613	2,2R 5%
3325	4822 117 13613	2,2R 5%
3327	4822 051 30105	1M 5% 0,062W
3328	4822 051 30333	33K 5% 0,062W
3329	4822 051 30479	47R 5% 0,062W
3333	4822 051 30332	3,3K 5% 0,062W
3334	4822 051 30332	3,3K 5% 0,062W
3335	4822 051 30472	4,7K 5% 0,062W
3336	4822 051 30221	220R 5% 0,062W
3338	4822 117 12925	47K 1% 0,063W
3343	4822 051 30103	10K 5% 0,062W
3346	4822 117 13613	2,2R 5%
3401	2120 108 93942	10K 1%
3404	2120 108 93944	22K 1%
3405	2120 108 93943	18K 1%
3406	4822 051 30103	10K 5% 0,062W
3410	4822 051 30109	10R 5% 0,062W
3411	4822 051 30109	10R 5% 0,062W
3412	4822 051 30101	100R 5% 0,062W
3413	4822 051 30101	100R 5% 0,062W
3414	4822 051 30101	100R 5% 0,062W
3415	4822 051 30103	10K 5% 0,062W
3416	4822 051 30103	10K 5% 0,062W
3417	4822 051 30103	10K 5% 0,062W
3418	4822 051 30563	56K 5% 0,062W
3419	4822 051 30474	470K 5% 0,062W
3423	4822 117 13632	100K 1% 0,62W
3424	4822 051 30472	4,7K 5% 0,062W
3425	4822 117 12925	47K 1% 0,063W
3426	4822 051 30105	1M 5% 0,062W
3427	4822 051 30105	1M 5% 0,062W
3428	4822 051 30103	10K 5% 0,062W
3429	4822 051 30474	470K 5% 0,062W
3430	4822 117 12889	270K 1% 0,063W
3431	4822 117 13632	100K 1% 0,62W
3434	4822 051 30472	4,7K 5% 0,062W
3435	4822 051 30223	22K 5% 0,062W
3436	4822 051 30472	4,7K 5% 0,062W
3437	4822 051 30222	2,2K 5% 0,062W
3438	4822 117 12925	47K 1% 0,063W
3442	4822 117 12925	47K 1% 0,063W
3456	4822 051 30101	100R 5% 0,062W
3457	4822 051 30101	100R 5% 0,062W
3460	4822 051 30103	10K 5% 0,062W
3466	4822 051 30008	0R JUMPER

ELECTRICAL PARTSLIST - MAIN BOARD**- RESISTORS -**

3467	4822 051 30008	0R JUMPER
3468	4822 051 30008	0R JUMPER
3476	4822 117 13632	100K 1% 0,62W
3477	4822 117 13632	100K 1% 0,62W
3478	4822 117 13632	100K 1% 0,62W
3479	4822 051 30109	10R 5% 0,062W
3480	4822 051 30109	10R 5% 0,062W
3481	4822 051 30109	10R 5% 0,062W
3482	4822 051 30008	0R JUMPER
3483	4822 051 30008	0R JUMPER
3484	4822 051 30008	0R JUMPER
3485	4822 051 30008	0R JUMPER
3489	4822 051 30101	100R 5% 0,062W
3490	4822 051 30101	100R 5% 0,062W
3493	4822 051 30109	10R 5% 0,062W
3494	4822 051 30008	0R JUMPER
3496	4822 051 30332	3,3K 5% 0,062W
3497	4822 051 30008	0R JUMPER
3498	4822 051 30479	47R 5% 0,062W
3499	4822 051 30008	0R JUMPER
3800	4822 117 12917	1R 5% 0,062W
3801	4822 051 30153	15K 5% 0,062W
3802	4822 051 30683	68K 5% 0,062W
3803	4822 051 30332	3,3K 5% 0,062W
3804	4822 051 30479	47R 5% 0,062W
3805	4822 051 30472	4,7K 5% 0,062W
3806	4822 051 30332	3,3K 5% 0,062W
3807	4822 051 30471	470R 5% 0,062W
3808	4822 117 12891	220K 1%
3809	4822 051 30563	56K 5% 0,062W
3830	4822 051 30109	10R 5% 0,062W
3831	4822 051 30562	5,6K 5% 0,063W
3832	4822 051 30562	5,6K 5% 0,063W
3833	4822 051 30562	5,6K 5% 0,063W
3834	4822 051 30562	5,6K 5% 0,063W
3835	4822 051 30273	27K 5% 0,062W
3836	4822 051 30273	27K 5% 0,062W
3837	4822 051 30333	33K 5% 0,062W
3838	4822 051 30333	33K 5% 0,062W
3839	4822 051 30333	33K 5% 0,062W
3840	4822 051 30333	33K 5% 0,062W
3841	4822 051 30103	10K 5% 0,062W
3842	4822 051 30103	10K 5% 0,062W
3843	4822 051 30103	10K 5% 0,062W
3844	4822 051 30103	10K 5% 0,062W
3845	4822 051 30103	10K 5% 0,062W
3846	4822 051 30103	10K 5% 0,062W
3848	4822 051 30333	33K 5% 0,062W
3849	4822 051 30102	1K 5% 0,062W
3850	4822 051 30223	22K 5% 0,062W

- RESISTORS -

3851	4822 051 30102	1K 5% 0,062W
3852	4822 051 30109	10R 5% 0,062W
3853	4822 051 30109	10R 5% 0,062W
3854	4822 051 30222	2,2K 5% 0,062W
3855	4822 051 30222	2,2K 5% 0,062W
3856	4822 051 30222	2,2K 5% 0,062W
3857	4822 051 30222	2,2K 5% 0,062W
3858	4822 051 30222	2,2K 5% 0,062W
3859	4822 051 30222	2,2K 5% 0,062W
3860	4822 051 30103	10K 5% 0,062W
3861	4822 051 30339	33R 5% 0,062W
3867	4822 117 12139	22R 5% 0,062W
3868	4822 117 12139	22R 5% 0,062W
3869	4822 051 30479	47R 5% 0,062W
3874	4822 051 30105	1M 5% 0,062W
3875	4822 051 30472	4,7K 5% 0,062W
3890	4822 051 30008	0R JUMPER
3891	4822 051 30008	0R JUMPER
3892	4822 051 30008	0R JUMPER
3893	4822 051 30008	0R JUMPER
3895	4822 051 30105	1M 5% 0,062W
3896	4822 051 30472	4,7K 5% 0,062W
3897	4822 117 13632	100K 1% 0,62W

- COILS & FILTERS -

5230	4822 157 11705	COIL 10μH
5250	2422 536 00438	IND FXD 40μH 30%
5251	2422 536 00058	2,2μH 20%
5300	4822 157 71206	BLM21A601SPT
5302	4822 157 71206	BLM21A601SPT
5304	2422 549 45355	IND FXD 100MHZ 390R
5400	4822 157 11074	FILTER 100μH

- DIODES -

6230	4822 130 11397	BAS316
6231	9322 128 70685	SS14
6232	4822 130 11397	BAS316
6233	4822 130 11397	BAS316
6250	3198 020 55680	BZX384-C5V6
6251	4822 130 11564	UDZ3,9B
6252	9322 128 70685	SS14
6253	4822 130 80622	BAT54
6254	4822 130 80622	BAT54
6257	9322 128 70685	SS14
6258	5322 130 34337	BAV99

ELECTRICAL PARTSLIST - MAIN BOARD

- IC & TRANSISTORS -

7231	3198 010 42310	BC847BW
7232	5322 209 82941	LM358D
7233	5322 130 60123	BC807-40
7241	5322 130 60123	BC807-40
7250	4822 130 42615	BC817-40
7251	5322 130 61569	BC868
7252	4822 130 60142	BC869
7253	3198 010 42310	BC847BW
7254	3198 010 42310	BC847BW
7256	9322 171 12671	SC111259AFTA
7268	3198 010 44350	BC807-25W
7269	3198 010 42310	BC847BW
7270	3198 010 42310	BC847BW
7271	3198 010 42310	BC847BW
7272	3198 010 42310	BC847BW
7273	4822 209 17289	74LV14PW
7276	3198 010 42320	BC857BW
7277	3198 010 42310	BC847BW
7278	4822 209 17289	74LV14PW
7300	4822 209 33165	TDA1308T/N1
7301	3198 010 42310	BC847BW
7302	3198 010 42310	BC847BW
7303	3198 010 42310	BC847BW
7305	4822 209 16083	BA3574BFS
7306	3198 010 42310	BC847BW
7307	3198 010 42310	BC847BW
7308	9322 181 94682	TC9235F
7400	3103 308 84521	TMP86CH21AF
7404	3198 010 42320	BC857BW
7405	3198 010 42310	BC847BW
7406	3198 010 42310	BC847BW
7480	9322 170 91671	TMS320DA150PGE160
7481	9322 166 67668	MT48LC4M16A2TG-7E
7482	3103 308 84460	EXP510
7483	9351 960 10118	74LVC139PW
7484	9322 158 50668	74LCX74T
7485	9352 499 80118	74LVC00APW
7800	4822 209 17286	TZA1024T/N1
7801	3198 010 42310	BC847BW
7802	3198 010 42310	BC847BW
7803	5322 130 60123	BC807-40
7830	9352 641 80557	SAA7324H/M2B

Note: Only these parts mentioned in the list are normal service parts.

ELECTRICAL PARTSLIST - JACK BOARD**- MISCELLANEOUS -**

1252	2422 026 05086	CONNECTOR 1P
1254	4822 267 11027	CONNECTOR 16P
1301	2422 026 05311	SOCKET PHONE 1P
1401	2422 129 16832	SWITCH PUSH 1P
1402	4822 277 21705	SWITCH

1408	2422 128 02833	TACT SWITCH
1409	2422 128 02833	TACT SWITCH
1410	2422 128 02833	TACT SWITCH

- CAPACITORS -

2324	4822 126 14549	33nF 16V X7R
2325	4822 126 14549	33nF16V X7R
2331	4822 124 12397	330µF 20% 6,3V
2332	4822 124 12397	330µF 20% 6,3V

- RESISTORS -

3322	4822 117 12917	1R 5% 0,062W
3323	4822 117 12917	1R 5% 0,062W
3339	4822 051 30331	330R 5% 0,062W
3340	4822 051 30331	330R 5% 0,062W
3402	4822 117 13632	100K 1% 0,62W

3403	2120 108 93943	18K 1%
------	----------------	--------

- COILS & FILTERS -





5252	2422 549 45355	IND FXD 100MHZ 390R
5253	2422 549 45355	IND FXD 100MHZ 390R

- DIODES -

6300	4822 130 11551	UDZS10B
6301	4822 130 11551	UDZS10B

Note: Only these parts mentioned in the list are normal service parts.

- MISCELLANEOUS -

328	 3140 118 32020	AC/DC ADAPTOR (for /01/11)
328	 3140 118 33630	AC/DC ADAPTOR (for /00C)
328	 3140 118 33610	AC/DC ADAPTOR (for /05)
328	 3140 118 33640	AC/DC ADAPTOR (for /17)
330	3140 113 10550	HANDSTRAP AY3286

335	3140 118 51170	REMOTE CONTROL AY3773
300	9082 100 00787	HEADPHONE HJ020/77E
8001	3140 110 22250	FFC FOIL 16P/40/16P

Note: Only these parts mentioned in the list are normal service parts.